

# LANDSCAPE MANUAL

**Anne Arundel County, Maryland**

Adopted by Bill No. 59-10  
July 27, 2010, and as Amended

# TABLE OF CONTENTS

<b>I.</b>	<b>INTRODUCTION</b>	<b>4</b>
<b>II.</b>	<b>GOAL AND OBJECTIVES</b>	<b>6</b>
	A. Goals	7
	B. Objectives	8
<b>III.</b>	<b>APPLICATION OF STANDARDS</b>	<b>11</b>
	A. Compliance with Manual Standards	12
	B. Compliance with Plans, Other Ordinances, Codes, and Regulations	12
	C. Exemptions to Manual Requirements	13
	D. Modification to Manual Standards	13
	E. Credit for Preservation of Existing Trees	14
	F. Retrofitting and Expansion of Existing Development	16
<b>IV.</b>	<b>GENERAL STANDARDS</b>	<b>17</b>
	A. Generation of Plant Quantities	18
	1. Planting Unit	18
	B. Screening	18
	1. General Requirements	18
	2. Buffer Requirements	19
<b>V.</b>	<b>LANDSCAPE &amp; SCREENING REQUIREMENTS</b>	<b>21</b>
	A. Street Trees & Streetscapes	22
	B. Parking Lots & Parking Structures	26
	1. Interior Landscaping	27
	C. Automotive Display Areas	28
	D. Nonresidential Structures	28
	E. Service Lanes	29
	F. Storage, Loading and Staging Areas	30
	G. Dumpsters, Mechanical/Electrical Equipment & Signs	31
	H. Stormwater Management Facilities, Including Bio-retention & Rain Gardens	32
	I. Small Business Districts (SBD), Drive Through and Fast Food Establishments	32
	J. Residential Rear and Side Yards Adjacent to Roads	33
	K. Residential Development Adjacent to Freeways	34
	L. Residential Development Adjacent to Single-Family Dwellings	35
	M. Residential Landscaping	35
	N. Historic Structures and Areas	37
	O. Scenic and Historic Roads	37
	P. Open Space (Publicly or Privately Owned)	38
	Q. Recreational Facilities	38

<b>VI.</b>	<b>PLAN PREPARATION, REVIEW AND APPROVAL</b>	<b>40</b>
A.	<b>Concept Landscape Plan (for Preliminary Plans, Sketch Plans, Variances, Special Exceptions)</b>	<b>41</b>
B.	<b>Final Landscape Plan (Final Plan of Subdivision or Site Development Plan)</b>	<b>42</b>
C.	<b>Implementation of Final Landscape Plan</b>	<b>42</b>
1.	<b>Security</b>	<b>42</b>
2.	<b>Release of Security</b>	<b>43</b>
3.	<b>Installation</b>	<b>43</b>
4.	<b>Compliance</b>	<b>43</b>
5.	<b>Warranty</b>	<b>44</b>
6.	<b>Maintenance</b>	<b>44</b>
7.	<b>Enforcement</b>	<b>44</b>
8.	<b>Inspection</b>	
<b>VII.</b>	<b>APPENDICES</b>	<b>45</b>
A.	<b>Definitions</b>	<b>46</b>
B.	<b>Exhibits 1-9</b>	<b>48</b>
1.	<b>Planting Unit Detail (Typical)</b>	<b>49</b>
2.	<b>Site Perimeter Buffer Requirements (Typical)</b>	<b>50</b>
3.	<b>Buffer Planting Composition (Typical)</b>	<b>56</b>
4.	<b>Street Tree Design</b>	<b>57</b>
5.	<b>Urban Streetscape Design</b>	<b>58</b>
6.	<b>Tree/Sign/Light Pole Placement</b>	<b>59</b>
7.	<b>Site Triangle</b>	<b>60</b>
8.	<b>Interior Green Space Plantings</b>	<b>61</b>
9.	<b>Tree and Planting Detail</b>	<b>62</b>
C.	<b>Planting Species Specifications &amp; Requirements</b>	<b>63</b>
D.	<b>Planting Soil Guidelines</b>	<b>66</b>
E.	<b>Landscape Plan Checklist</b>	<b>70</b>
F.	<b>Plant List of Non-Recommended Plants</b>	<b>71</b>
G.	<b>Native Plant Species List</b>	<b>73</b>
H.	<b>Street Tree Plant List</b>	<b>76</b>
I.	<b>Planting and Landscape Cost Estimates</b>	<b>78</b>
J.	<b>Approved County Bill and Amendments</b>	<b>79</b>
<b>VII.</b>	<b>REFERENCES</b>	<b>80</b>

# I. INTRODUCTION

## **I. INTRODUCTION**

The County Council approved Anne Arundel County's first landscaping requirements on October 4, 1982 (Bill No. 129-82). In response, the Office of Planning and Zoning developed the County's first Landscape Manual in 1982. Since the 1982 appearance of a County Landscape Manual, there have been numerous changes to subdivision and zoning regulations, in addition to the Maryland's Forest Conservation Act of 1993, which prompted changes to County law.

The first reference to the Landscape Manual in County law was in 1996 (Bill 70-96). The County Council has since directed the Office of Planning and Zoning to revise the Landscape Manual and submit it to the Council for adoption by ordinance (Bill No. 76-99).

This Manual is the result of the enactment of new comprehensive Subdivision, Development and Zoning articles in 2005. The Council once again directed the Office of Planning and Zoning and the Office of Law to submit for review and enactment of a revised Landscape Manual.

This update has been prepared to bring the Landscape Manual (hereinafter, "Manual") into conformance with current law and practice and to incorporate revisions to county processes being contemplated by the Council relating to the States new stormwater management regulations.

## **II. GOALS AND OBJECTIVES**

## **II. GOALS AND OBJECTIVES**

Landscapes in Anne Arundel County range from undisturbed estuarial lands, rural forest and pastures, to residential developments of varying densities, some bordered by commercial corridors, to urban streetscapes and business complexes. Institutions such as hospitals, colleges, schools, and religious facilities contribute attractive estate-like landscapes that generate a sense of spaciousness to their communities. It is the goal of this Manual to reflect the purpose of landscape in relation to environmental quality, rural development, community conservation efforts, and economic enhancement in commercial areas.

### **A. GOAL**

Landscape elements should be used for land development in an organized and harmonious fashion that will enhance the physical environment of Anne Arundel County for the benefit and enjoyment of its citizens. Landscaping should be used to:

- improve environmental quality and protect existing vegetation
- enhance and create habitat for local and migratory animals
- improve water quality
- preserve rural character and safeguard natural landscapes
- contribute to the stability of the neighborhoods
- enhance neighborhood security and property values
- foster the economic vitality of commercial development

#### **Environmental Quality**

Development is subject to various environmental regulations: forest conservation, storm water management, sediment and erosion control, environmental features buffers and Chesapeake Bay critical area requirements. Where the Forest Conservation Act or other environmental regulations achieve the goal of protecting natural resources, this Manual does not impose overlapping regulations. However, Landscape Manual requirements may be used to satisfy Forest Conservation Act requirements as defined herein.

It is the goal of Anne Arundel County to safeguard the purity of its air resources and to control detrimental impacts from air pollutants upon public health, property, environmental resources, and climate. In conjunction with the County's forest program and regulations, the Manual encourages the retention and the planting of trees that help reduce greenhouse gases and ambient air pollution. Especially in urban areas where small stands of trees do not qualify as forest, the Manual is a tool for implementing the County's policies of goals of controlling air pollution and improving the comfort and safety of the built environment. Wooded and landscaped areas also enhance cooling and sheltering of buildings and increase habitat diversity.

#### **Preservation of Rural Character**

The rural landscape of much of Anne Arundel County represents a precious heritage containing some of the oldest cultivated terrain and most historically significant places in North America. The site layout and landscape patterns of new development should incorporate design

principles that will help retain the essential visual, spatial and environmental qualities of the traditional landscape. Natural landscapes should be treated with sensitivity and respect.

### **Community Conservation**

Development since the 1970's has generally provided heterogeneous housing types. These must fit into existing neighborhoods with varied contexts. New development should use recognizable landscape styles or themes that identify the unique character of the existing neighborhood. New landscape designs should complement and enhance the neighborhood. Infill projects should provide appropriate landscape transitions between new and existing structures, drives and parking areas.

### **Neighborhood Security**

Landscape design must be sensitive to public safety concerns and the perception of a comfortable and safe environment. Neighborhood security is built on the ability of people to feel responsible and in control of their surroundings. Landscape design must allow surveillance of private and public properties, open spaces, and roadways that make up neighborhoods. Design and maintenance of planting and lighting play important roles in providing a secure neighborhood environment. Landscape areas in residential and commercial developments should be maintained and kept free from refuse and debris to present a healthy and prosperous appearance.

### **Commercial Image**

The County's older communities are largely built-out and have well-established physical and social structures. They are often characterized by traditional homes, tree-lined streets and an interconnected road network. Commercial areas are often an integral part of older communities and have a strong impact on the viability and public perception of the neighborhood. Commercial corridors provide the main travel ways that connect people from work, schools and shopping to their homes. Commercial areas on travel ways must be clean, well maintained, comfortable and appealing to passersby in order to reflect positively on adjacent residential areas. The landscape treatment of commercial development plays an important role in expressing the economic vitality of commercial corridors and securing the stability of adjoining neighborhoods.

## **B. OBJECTIVES**

Landscape is an essential element of site design. Basic planning principles to address image, circulation, open space, and recreation must be employed if the objectives are to be accomplished.



The objectives of this Manual used in conjunction with other county ordinances and manuals are summarized as follows:

1. Provide landscape design that is functional, aesthetically beneficial, cost-effective and environmentally sensitive.
2. Foster site design that preserves natural vegetation and landforms. Preservation of existing trees and vegetation, regardless of size, should be incorporated whenever possible. Preserve trees or vegetation, which have special character due to size, age, habit or historical importance.
3. Articulate spatial relationships and provide image and structure to the built environment.
4. Mix a variety of plant material due to possible insect infestation that potentially could destroy a significant portion of a particular species.
5. Complement the built environment through planting that reduces soil erosion, establishes comfort zones and windbreaks, provides visual screens and buffers, reduces glare, noise, and heat, and provides shade.
6. Integrate aesthetic qualities of landscape elements including form, size, texture, and color into the landscape. Existing and proposed topography and landforms should be used to accent, screen and direct landscape compositions. Grading, earth berms, and plants may be used to define outdoor spaces and create vehicular and pedestrian circulation patterns. Plants are used to modify climate by reducing solar radiation and creating cooler temperatures by shading the sun. Plants also can be used to modify wind direction by blocking winter winds and enhancing summer breezes, controlling soil erosion, and establishing wildlife cover by providing cover and food for birds and other wildlife.
7. Design Landscape plans that include a comprehensive approach to provide site unity and harmony with site elements and landscape plantings. Contrast, repetition, and focal points are among the many principles used to create integrated and unified planting plans. Planting guidelines are as follows:
  - Large deciduous trees provide unity, character, and identity for residential development as well as a human scale for non-residential neighborhoods. Street trees perform basically the same function but have specific relationship to the street by defining and unifying the streetscape.
  - Ornamental trees provide an understory canopy for overhead major deciduous trees. They provide color, scale, and definition to smaller spaces by accenting and transitioning the landscape into architectural elements.
  - Evergreen trees are used to screen and define spaces and control views. They provide winter interest, accent, definition and transition with a variety of form and color that soften inorganic landscape elements.

- Shrubs, perennials, ornamental grasses, and turfgrass define landscape spaces and direct pedestrian traffic. They should be massed in mulched beds to provide color, variety, and accent, or control erosion.
8. Establish landscape design criteria that includes principles and standards such as, groups of informal plantings to mimic natural landscapes, compatibility of built structures with plant materials, year round effect for screening materials, plant selection with appropriate rate of growth, minimal maintenance requirements, and tolerant of site conditions such as, sun, wind, drought, glare, reflected heat, salt and chemicals.
  9. Include landscape elements such as fences, walls, earth berms, and evergreen plantings that are carefully placed in the landscape to avoid obstruction of views and prevent restricting light and air.
  10. Insure that environmental features, such as floodplains, wetlands, and steep slopes be left in their natural condition as much as possible. Grading should follow the original topography to minimize disturbance of existing vegetation. Avoid compaction and development within critical root zone of trees.
  11. Preserve the integrity of historic properties by designing development on adjacent properties to minimize visual impact and maintain original context.
  12. Insure that through creative and sensitive application of many related elements, the landscape architect and other design professionals can effect a successful integration of architectural and landscape elements into the environment. A thorough understanding of these elements and their effective application will result in a positive addition to the community as well as pleasant individual experiences for the citizens of the area.

### **III. APPLICATION OF STANDARDS**

### **III. APPLICATION OF STANDARDS**

#### **A. COMPLIANCE WITH MANUAL STANDARDS**

1. All development needing a Subdivision, Site Development Plan, Grading, or Building permit, shall comply with the standards in this Manual unless specifically exempted in paragraph C below.
2. Screening in conformance with this manual may be required when a change of occupancy results in new storage or loading areas.
3. Landscaping required in conjunction with a modification, special exception, or zoning variance must meet the standards of this Manual as conditioned by the Planning and Zoning Officer, Administrative Hearing Officer or the Board of Appeals.
4. Conversion of an existing residential use to a nonresidential use shall comply with the standards of this Manual.
5. Mobile home parks, allowed by special exception, shall comply with the landscape standards for residential development.
6. Institutional uses, such as religious facilities, schools, assisted living facilities, and nursing homes in any zone, and other non-residential uses located in residential zones shall comply with the landscape standards for commercial development.
7. Residential subdivisions of five lots or less involving rear orientations to public roads; flag lot driveways; scenic or historical roads and associated views; or historic properties are subject to the landscape standards for "Condition L, Residential Rear and Side Yards Adjacent to Street;" "Condition N, Historic Structures and Areas", and "Condition O, Scenic and Historic Roads" found in Chapter V.

#### **B. COMPLIANCE WITH PLANS, OTHER ORDINANCES, CODES, AND REGULATIONS**

It is the intent of the County government to obtain development that responds to human needs, is socially positive, economically viable, and environmentally satisfying. These standards are designed to meet the stated objectives.

1. These standards shall not relieve the applicant of responsibility of compliance with all applicable federal, state and local ordinances, codes and regulations. Where federal or state ordinances, codes, and regulations permit lower standards than required herein, the County's requirements shall govern.

2. Provisions of the most recent version of the Anne Arundel County Code at time of application shall prevail in the event of any conflict between the Code and the Landscape Manual.
3. The provisions of the Landscape Manual may not supersede any provision of the latest Anne Arundel County Code, relating to forest conservation, including provisions for "Grading and Sediment Control", and "Subdivisions", pertaining to the establishment of forest conservation thresholds, priorities for retention, standards for mitigation, and afforestation and reforestation.
4. All developments must be in substantial compliance with landscape, buffer yards and screening recommendations included in adopted area plans, revitalization plans or other plans adopted as part of the current General Development Plan and Small Area Plans.

### **C. EXEMPTIONS TO MANUAL REQUIREMENTS**

The following development is exempt from the landscape Manual's requirements:

1. Existing single-family residential lots and agricultural development in the RA zone.
2. Residential subdivisions of five lots or less not involving the following site conditions: rear orientations to public roads; flag lot driveways; storm water management facilities; scenic or historic roads and associated views; and historic properties.
3. Sites located in an overlay zone or town center where other sections of the county code supersede this Manual.

### **D. MODIFICATION TO MANUAL STANDARDS**

1. The standards in this manual are intended to foster creative design solutions. Conditions may arise where full compliance is impractical or impossible, or under circumstances where maximum achievement of the County's objectives can only be obtained through modified requirements. (e.g...urban standards in town centers). If another section of the county code or town center plan does not already supersede this manual, the Office of Planning and Zoning may approve a proposed modification of these standards if the modification more fully achieves the objectives contained herein, or in other county plans. **Modifications shall be limited to a specific project under consideration, shall not establish a precedent for other cases and shall comply with Article 17-2-108 of the Anne Arundel County Code.**
2. Minor modifications of an approved landscape plan due to plant availability, and unforeseen field conditions may be authorized by the Office of Planning and Zoning provided the general design and plant characteristics, and cost

associated with the modifications as shown on the approved plan would not be significantly altered.

3. All requests for modifications must be submitted to the Office of Planning and Zoning in writing, clearly stating the reasons and relative impact of the modification with sufficient explanation and justification, written and/or graphic, to allow appropriate evaluation and decision by the Office of Planning and Zoning.
4. The Planning and Zoning Officer may approve an application for a modification to any provision of the requirements of the Landscape manual if the modification satisfies the intent of the requirements that is being modified and:
  - a. It is necessary to address topographic, soil, or other site conditions that make compliance with the requirement impossible or impractical, to mitigate safety concern, to maintain the character of a scenic or historic road, or historically significant property, and to protect a vista associated with that roadway or property.
  - b. It enhances environmental quality or improves the overall function of the plan and its relationship with neighboring properties.
  - c. It meets the requirements for modifications found in Article 17 of the county code.
5. For development located within town centers, or community center districts on lots that are irregular, confining, or have other unusual site constraints such as determined by the Office of Planning and Zoning, the required landscape areas may be amended provided:
  - a. the reduction of required landscape areas does not negatively impact adjoining uses; and
  - b. the reduction of required landscape areas does not negatively impact the streetscape as defined by building location, landscape areas, walkways, street landscaping, etc.
6. When modifications are submitted for required landscaping or when zoning variances are requested to minimum standards, the Office of Planning and Zoning or Administrative Hearing Officer may require additional landscape improvements.

#### **E. CREDIT FOR PRESERVATION OF EXISTING TREES**

The developer is encouraged to save the maximum number of trees in accordance with the following guidelines:

1. The following determinants shall be used in selecting trees to be saved when development is exempt from Forest Conservation Requirements:
  - a. Trees to be retained must meet the minimum size requirements in accordance with American Association of Nurserymen (AAN) standards and this manual.

- b. A circle, radius equal to one foot per inch of diameter at breast height (DBH), shall be drawn around all trees to be retained outside of conservation boundaries.
    - c. If more than 30 percent of the critical root zone is to be disturbed, the tree shall not be included as retention.
  2. Upon notification of County approval of a Final Subdivision or Site Development Plan, trees that are to remain shall be marked in the field by the developer, inspected by the County, and protected in an approved manner. Trees within the construction area, which are to remain undisturbed, shall be encircled with a fence for protection (snow fencing or other approved methods). The contractor shall not disturb the area within the fence in any manner including, but not limited to:
    - a. running or parking construction equipment
    - b. storage of deleterious, flammable, or any other construction material or debris
    - c. soil stockpiling
    - d. allowing standing water or fires
    - e. alteration of grades in adjacent areas that will cause drainage to flow into, or to collect in protected areas
  3. All trees to be removed should be removed in a manner that will not damage the remaining trees. Any trees that are to remain that are damaged during the clearing operation must be repaired in an approved manner by a licensed arborist as soon as final clearing has been completed. After construction is completed, temporary barriers, surplus materials and all trash, debris and rubbish shall be removed from the site. All backfill shall be clear of building material, stone, and rubbish.
  4. Existing trees (particularly mature trees) that are retained will undergo "post-operative shock" caused by the construction activity. All possible safeguards, as determined by a licensed arborist, should be taken to minimize these effects and to provide optimum growth conditions. Foliage feeding and liquid or root feeding are encouraged. Branch and foliage thinning are also desirable. Existing trees that do not survive will require replacement planting on a 1:1 basis.
  5. Credit shall be given on a 1:1 basis for existing major trees preserved when they are in a location and of a nature that they contribute to the objectives and guidelines of the Manual.
  6. Buffers may be increased to a minimum of 35' width to count towards reforestation and/or woodland retention requirements for the site. Refer to the Maryland Forest Conservation Manual for reforestation/woodland retention criteria.

**F. REDEVELOPMENT, RETROFITTING AND EXPANSION OF EXISTING DEVELOPMENT**

Providing trees and installing ornamental landscaping and screening can have a positive effect on property values. Property owners are encouraged to retrofit existing developed properties to the standards of this manual to the extent possible. Alterations or expansions of existing developments shall be subject to the following criteria:

1. For properties where the alteration or expansion involves a 50 percent increase of the gross floor area or intensity of use, or a 50 percent increase in the parking area or number of parking spaces, the property must be landscaped (screening and internal planting), in full compliance with the standards in this manual.
2. The portion of the site impacted by the alterations shall conform to the standards in this Manual or upgrades to the entire perimeter dependant upon site conditions and proximity to public rights-of-way and residential areas.
3. The Office of Planning and Zoning may modify these requirements in instances where the installation of the landscape screening is impractical, or if interior landscaping may be more appropriate.
4. Landscaping shall be coordinated with and augment SWM retrofit requirements, per the current Stormwater Management Practices and Procedures Manual.



## **IV. GENERAL STANDARDS**

## IV. GENERAL STANDARDS

### A. GENERATION OF PLANT QUANTITIES

Minimum required plant quantities shall be based on Planting Units. The use of Planting Units allows more creative planting design, and encourages use of a greater variety of plant types. Sizes shall be in accordance with American Association of Nurserymen (AAN) standards.

1. One Planting Unit equals: (See Exhibit 1 )
  - one major deciduous shade tree 2 - 2 ½ inches in caliper at installation and 3 shrubs or;
  - two minor deciduous trees 1 1/2 to 1 3/4 inches in caliper at installation and 5 shrubs or;
  - three evergreen trees, 6 feet in height at installation
2. Tree caliper shall be measured at a distance of 6 inches above the root ball for trees 4 inches or less in caliper.
3. Evergreen trees shall adequately screen the level of visibility and height required for the screening effect. Shrub plantings shall be a minimum of 60 percent evergreen depending on intended purpose.
4. Shrubs shall be 24 – 36 inches in height at installation; or  
\*ten herbaceous perennial plants at 1-gallon size; or twenty herbaceous perennial plants at one-quart size  
*(\*may only be used to meet Class A screening for visual relief from paved areas adjacent to existing nonresidential)*
5. Expected growth of herbaceous perennial plants is 24 inches within one year, contained within a single mulched bed. Herbaceous perennials may only be substituted for shrubs as noted above and where conditions limit shrub planting.

### B. SCREENING

1. General Requirements
  - a. Screening is required to diminish the impact of undesirable views and mitigate the visual conflict and other effects (noise, fumes, and light spillover) of adjacent dissimilar land uses. Screening will consist of: trees and shrubs; fences; earth berms in conjunction with planting materials; or solid brick or split-faced block walls. The degree of intensity of adjacent land uses and width of landscape plantings available as a buffer will dictate the height, density, opacity, and landscape elements required.
  - b. Screening is required for dumpsters, storage and loading areas, service lanes, parking lots, and other conditions and development adjacent to commercial, industrial, institutional, and residential zones or uses as listed in this Manual.
  - c. All green areas shall be designed and improved to enhance pedestrian circulation areas and to provide effective buffers and visual relief between roadways, parking, and buildings in accordance with the requirements of this "Manual".

2. Buffer Requirements (See Exhibits 2 & 3)

<b>SITE PERIMETER BUFFER REQUIREMENTS</b>						
<i>CLASS</i>	<i>FUNCTION</i>	<i>WIDTH</i>	<i>PLANTING UNITS</i>	<i>HEIGHT</i>	<i>PROPOSED USE</i>	<i>ADJACENT USE</i>
<b>A</b>	Solid Linear to Loosely Staggered for Needed Level of Visual Relief	10'	1 Per 20 lf	***24"	Commercial, Institutional & Light Industrial	Existing Nonresidential
	Maximum Screening/ Restrict Pedestrian Movement	15'	1 Per 15 lf	3'-6' *Year-round Screen		Existing Residential or Public Open Space/Area
<b>B</b>	Maximum Screening/ Restrict Pedestrian Movement	10'	1 Per 15 lf	**6'	Heavy Industrial	Existing Nonresidential
		25'	1 Per 10 lf			Existing Residential or Public Open Space/Area
<b>C</b>	Visual Relief From Adjoining Property	15'	1 Per 10 lf	N/A	Multi-family	Existing Nonresidential
		25'				Existing Residential or Public Open Space/Area
<b>D</b>	Visual Relief From Public Rights-of-Way	15'	1 Per 15 lf	3'-6' *Year-round Screen	All Proposed Development Excluding Single-Family Dwellings	GDP Ultimate R/W ≤ 60'
		25'	1 Per 10 lf	***N/A		All Proposed Development Excluding Single-Family Dwellings
<b>E</b>	Heavy Screen	50'	1 Per 10 lf	***N/A	All Proposed Development	Freeways & Expressways

- \* A 3'-6' high opaque, non-degenerative, fence, wall or earth berm may be required in conjunction with planting.
- \*\* A 6' high earth berm, masonry wall, non-degenerative board-on-board fence, or sound barrier wall may be required in conjunction with planting.
- \*\*\* Mature planting shall be a minimum of 24 inches in height, measured from the top of curb of the adjacent road.
- \*\*\*\* Existing woodland shall be retained where screening is required. Selective clearing or removal of understory may be permitted to allow visibility into the subject site where appropriate.

- a. For redevelopment in commercial corridors, a brick or pre-cast block wall may be considered as an alternative where the minimum landscape strip is not feasible.
- b. All fractional requirements shall be rounded up.
- c. Fence Specifications
  - i. For board-on-board fences, the minimum frame size shall be 2x4 and minimum post 4x4.
  - ii. Fences or walls should be constructed of durable, non-degenerative, low maintenance materials coordinated with the materials used on building facades.
  - iii. Fencing and/or walls should usually be placed on the inside edge of the landscape strip with planting on the residential or street side of the fence or, in 25' or wider buffers, placed to allow planting on both sides of the fence. Fencing shall be located at the grade elevation that best maximizes screening.
  - iv. Monotonous stretches of a single fence type may be attenuated by changes in height, material, offsets, or other articulation. Planting unit shall be spaced at a minimum of every 30' to relieve monotony.
  - v. Fence location should avoid the creation of dead spaces between properties that are difficult to maintain or secure.
  - vi. Security fencing along public rights-of-way shall be set back 10 feet to allow planting on the street side of the fence.
  - vii. Security fencing for self-service storage facilities along public rights-of-way shall be ornamental (e.g., metal pickets with masonry piers). The Office of Planning and Zoning may also require ornamental fencing for other nonresidential uses adjacent to public rights-of-way.
  - viii. Proposed grades, fence location, and construction details are required on the Landscape Plan.

**V. LANDSCAPE & SCREENING**  
**REQUIREMENTS**

## **V. LANDSCAPE & SCREENING REQUIREMENTS**

This section is designed to assist the plan preparer and the reviewer in realizing the goal and objectives of the Manual through a combination of landscape elements. In this section, illustrated guidelines address specific project conditions to provide flexibility in design solutions to meet the Manual's objectives.

Project conditions that generate landscape requirements may be existing or created. They may be on-site or on adjacent or surrounding property. The conditions relate to the use of and impact on public and private vistas. The appropriate landscape elements are those that respond to and compliment project conditions.

### **A. STREET TREES & STREETSCAPES**

#### **Objectives**

- Delineate vehicular and pedestrian circulation patterns to improve the comfort and safety of pedestrians.
- Establish a planned combination of design elements that follow a unified theme or pattern.
- Establish human scale and provide visual relief from expansive road and parking surfaces.
- Incorporate community image and identity within the streetscape design.
- Site development and road alignment should seek to preserve existing woodlands and stands of existing trees.
- An essential part of the intent of this manual is the requirement for a unified type and design for street trees, plants and furniture. Street trees and other furniture perceptibly shall define the boundaries between public and private space. This distinction between spaces promotes privacy, noise reduction, maintenance of the natural habitat, and conservation of natural resources.
- Streetscapes are an important component of the public domain, where people often interact, which help to define a community's transport conditions, activities, aesthetic quality and identity.
- Create multi-purpose streetscapes that can safely move pedestrians and bikes while serving as an aesthetic public space.

#### **Guidelines**

- Streetscape and buffer requirements are in addition to Street Tree requirements and shall be calculated separately.
- Improve the comfort and safety of pedestrians by planting canopy trees between the curb and sidewalk.
- Define the travel way and provide canopy over the street with formal plantings.
- Frame views of buildings, displays, and signs by clustering of trees in consolidated planting areas.
- Preserve existing woodlands and stands of existing trees where possible.
- Consider site distance and visual obstructions when locating street trees.

- Rural roads may be suitable for formal or informal arrangement of street trees. Formal rows of canopy trees along entry roads create an estate-like setting. Groves or informal clusters frame views and blend in with the rural landscape. Trees can be arranged in groves or informal clusters, to frame views and blend in with the landscape when adequate space is available.
- Small Area Plans, County master plans, revitalization plans and streetscape policies establish design criteria for commercial corridors and local streets that may address walkways, light fixtures, street furniture, signs, and planting requirements.
- Coordinated design features such as decorative plantings, flowering trees, evergreen trees, architectural elements, signs and lighting can accent intersections and form neighborhood gateways.
- Earth berms can provide interest to the streetscape design.
- Flowering and evergreen trees and shrubs accent entrances and signs.
- Overhead and underground utilities may require unique design solutions to complete the streetscape design.
- Landscaped turnarounds provide privacy and an open space focal point for courts.
- Landscaped medians and roundabouts provide a visual separation between driving lanes and help direct traffic while increasing aesthetic quality.

### **General Standards**

1. Placement of plant materials shall conform to the standards, guidelines and objectives contained in the Manual and, in addition, shall comply with Small Area Plans, Town Center Plans, commercial revitalization plans, Department of Public Works streetscape policies, and requirements of the Storm Water Management Manual.
2. To the extent that the more urban requirements in the Parole Town Center Growth Management Area or the Odenton Town Center District may be deemed to require alternative landscaping and streetscape, the requirements of those overlay districts or design guidelines will govern. If not, the landscape standards contained in this Manual apply.
3. In instances where significant natural vegetation exists, the Office of Planning and Zoning may limit the extent of clearing and grading to protect and preserve the area. These natural areas will not be disturbed by the installation of any structures, utilities, storm and sanitary sewers, water lines, sediment and erosion control devices, stormwater management systems, and signage unless approved by the Office of Planning and Zoning.
4. Where pedestrian and bike paths are proposed within a landscape buffer, such paths shall be meandering so as to preserve existing trees.
5. Commercial interior and exterior roads adjacent to residential zones or uses require a 25-foot landscape buffer with "Class D" screen.

## Street Tree Standards (See Exhibit 4)

1. The Office of Planning and Zoning shall provide a 100% credit towards street tree requirements for existing trees preserved along roadways, within the right of way immediately abutting the right of way. No additional street trees will be required for the portion of the roadways for which trees are retained.
2. For the purpose of establishing the minimum quantity of trees required, use one Planting Unit per 40 feet of adjacent roadway. Provide a variety of interest and unity with street tree species selection. (See Appendix 'H': Street Tree Plant List)
3. Location Requirements:
  - a. When the distance between the curb and the sidewalk is 5 feet or greater, trees should be located within the right of way and shall be centered between the sidewalk and the curb.
  - b. When the distance between the curb and sidewalk is less than 5 feet, the trees may be planted 3 feet from the outside edge of the sidewalk. If the area of tree planting falls outside the road right of way, a 10 foot wide planting easement is required. The easement may be expanded to accommodate the placement of the trees.
  - c. Trees shall be planted 6 feet behind the curb when there are no sidewalks involved unless prohibited by utility structures.
  - d. Trees shall be planted at least 20 feet from all traffic control signs and/or shall not interfere with the visibility of the sign. Such trees shall not interfere with utility lines or structures above or below ground. Street trees shall not be planted within 5 feet of a private drive.
  - e. Street trees shall not be planted within a sight triangle at the intersection of public or private roads.(See Exhibit 7) This sight triangle is formed by the edge of pavement measured from the apex of the intersection of the pavement edges back 25 feet, then connecting the pavement edges by a third, imaginary line. No planting above a 2 foot height shall be planted within this triangle. Trees already existing must have the lower branches removed to a height of 7 feet.
4. In all zoning districts the following standards apply:
  - a. Major deciduous trees shall have a minimum size of 2 – 2 ½ inch caliper as measured by AAN standards.
  - b. Developer or owner shall maintain landscaping provided within rights-of-way, and landscaping should reflect design appropriate to the nature and intensity of use for which the property and adjacent properties are zoned. (This may call for automatic watering devices, under drains, appropriate planter design, etc.)
  - c. Trees may be arranged in groves or informal clusters, to frame views and blend in with the landscape when adequate space is available.
  - d. Spacing of trees may be modified to accommodate utilities, sight distances, and visibility for traffic control signs.



## Urban Streetscape Standards (See Exhibit 5)

Urban Streetscape standards are to be utilized in and around urban areas such as, but not limited to, Town Centers, Planned Unit Developments, Commercial Revitalization Districts, and Mixed Use Developments where certain corridors are designated for special treatment, to ensure that they become active urban spaces that attract pedestrian activity.

1. Awnings are encouraged at building entrances and windows to provide cover over the sidewalk, to create an intimate space along the sidewalk for window shopping and to reduce the scale of a building for pedestrians. Awnings must be at least 7 feet above the sidewalk at their lowest point with any supporting structure located a minimum of 8 feet above the sidewalk.
2. Adequate lighting of the sidewalk and street area is essential to creating a safe and inviting streetscape. Additional street lighting may be necessary to achieve the appropriate levels needed within the business area
3. Street furnishings provide an important level of detail that improves the comfort and convenience of the streetscape for pedestrians and business patrons. Facilities to accommodate transit use and to enhance personal safety are also important to the quality of the streetscape.
  - a. A minimum of one (1) bench will be provided at the street frontage of each project.
  - b. At a minimum, one (1) waste bin will be provided for each property.
  - c. Bicycle parking spaces shall be provided for all new buildings and for existing buildings undergoing renovation at a minimum of one bicycle space for every 20 required automobile spaces. Bicycle parking shall be located within easy access from the street.
4. Recycling facilities should be included in the streetscape at locations convenient for use as pedestrian activity increases and the need warrants.
5. Property owners are responsible for maintaining all sidewalks, street trees, and building fixtures that overhang the sidewalk such as awnings or light fixtures along their street frontage. Maintenance of any vegetative plantings in tree planter areas or in above sidewalk planters shall also be the responsibility of the property or business owner.
6. The building façade that faces the street and the associated pedestrian frontage area is the focal point of the building and lot. It is important to maintain and encourage quality architectural design to be carried through to the street and the pedestrian level.

## **B. PARKING LOTS & PARKING STRUCTURES**

### **Objectives**

- Screen parking lots from adjacent public rights-of-way and from adjacent residential uses, property lines, or zones including townhouses, single-family attached, and multi-family development.
- Provide shade and visual relief to paved areas.
- Delineate vehicular and pedestrian travel ways.
- Integrate parking areas into existing terrain and vegetation.
- Integrate interior green areas and larger planting areas.
- Include bio-retention and other water quality BMP's into plantable areas and buffers where practicable.
- Screen views of cars at ground level.
- Avoid views of monotonous building mass.

### **Guidelines**

- Parking lot screening contributes to the streetscape design.
- Earth berms and grade changes help to screen parking areas.
- Fences or masonry walls help secure parking areas.
- Low walls combined with plantings define project boundaries and image.
- Design landscape strips between commercial properties to allow coordinated planting by the adjacent commercial property when redevelopment occurs. A minimum of 50% of the planting units should be major trees. Grade change, existing fencing or walls, and anticipated project phasing are considerations.
- Required interior landscaping is installed in peninsulas, islands, or planting breaks to separate:
  - a) parking lot entrances from adjacent parking spaces
  - b) interior roads from parking bays
  - c) changes in aisle and bay orientation
  - d) interior drives from parking spaces
- Grade changes are accommodated within parking lot medians.
- Consolidated landscape areas allow planting in groves and incorporate existing vegetation.
- Consolidate interior landscape areas to preserve specimen trees.
- Shade trees planted within landscape islands and medians visually interrupt parking bays, provide shade and reduce glare.
- Landscape islands, curb returns and medians define circulation patterns and provide pedestrian access.
- Planting in small groups within larger parking lot medians rather than single trees in minimum size medians enhance tree survivability.
- Where permitted by building setbacks stipulated in Article 18, buildings should be located on the site to screen proposed parking from public rights-of-way and residential property (zone and/or use).
- Rear facades/loading docks should not face public rights-of-way or residential properties, but if visible should be screened and articulated in such a manner to mitigate

the visual impact (i.e. screening walls composed of the same material as the proposed building, evergreen trees, etc.)

- Masonry walls and ground level plantings should provide screening between column supports where the ground floor is occupied by vehicle storage.

## Standards

### 1. Interior Landscaping (See Exhibit 8)

- a. Reserve 10% of the parking lot area including parking spaces, drive aisles, and loading spaces for interior landscaping. Plant at one Planting Unit per 250 square feet.
- b. Landscape islands and medians shall be planted with trees, shrubs and living ground covers or turf.
- c. The minimum width of parking lot medians or islands shall be 13 feet from face of curb to face of curb, with a minimum of 9 feet for retrofitting of existing parking lots.
- d. When parking spaces abut a building, the face of the curb or parking lot edge shall be a minimum of 10 feet from the face of the building to accommodate a 5-foot planting area and 5-foot sidewalk.
- e. A parking lot containing 5,000 square feet or less of paved area, including drive aisles and parking spaces is exempt from providing interior landscaping.
- f. In parking lots greater than 5,000 square feet, including drive aisles and parking spaces, landscape islands are required for every 12 parking spaces, unless interior open area has been met by consolidating into larger areas within the parking lot. It is recommended that planting islands be increased in size to accommodate planting of trees in groups rather than in a linear method.
- g. Unloaded drive aisles shall be separated from abutting parking spaces by a 9-foot wide minimum planting area.
- h. All green areas within a parking lot shall be credited as interior landscaping except for required buffers, perimeter green areas, and islands or portions of islands which cannot be planted with trees and shrubs due to conflicts with utilities, storm water management devices, easements, etc.
- i. Parking lot medians are required between every third row of parking unless interior open area has been met by consolidating into larger areas within the parking lot.
- j. Bio-retention and other storm water management best management practices should be integrated into green areas wherever practical.

## **C. AUTOMOTIVE DISPLAY AREAS**

### **Objectives**

- Provide attractive display areas that complement the streetscape.
- Maintain public rights-of-way and sidewalks clear of parked vehicles.
- Provide visual relief from expansive parking areas.

### **Guidelines**

- Simple planting combinations used in bold layouts emphasize display areas.
- Clustering trees at entrances, buildings and property corners helps frame views of display areas and showrooms.
- Low earth berms with ground covers or lawn provide an attractive foreground for auto displays when the landscape setback is adequately increased.
- Architectural elements integrate signage and logos within the landscape area.
- Curb stops, properly anchored, protect planting areas and define parking and driveways.
- Interior planting areas filter views of storage lots.

### **Standards**

1. Display parking areas are subject to the criteria for interior landscaping of parking lots.
2. A minimum 6-inch high curb or wheel stop is required to separate the parking surface from the planting area to discourage placing vehicles in the planting area but still allowing proper drainage.
3. Automobiles shall not be placed or displayed within the landscape buffer or public right-of-way.
4. Areas dedicated to customer parking and employee parking are subject to Section V. B. Parking Lots & Parking Structures. Areas dedicated to storage of vehicles are subject to Section V. F. Storage, Loading and Staging Areas.

## **D. NONRESIDENTIAL STRUCTURES**

### **Objectives**

- Provide a highly compatible transition or buffer between residential and more intense office, commercial, industrial, or institutional use.
- Buffer residential properties from the visual and acoustical impacts associated with non-residential and other incompatible land uses.
- Enhance the privacy of residential developments.
- Define the boundaries between different land uses.
- Maintain residential character by preserving the residential appearance and residential setting of buildings converted to office or institutional use.

## **Guidelines**

- The building landscaping provides a transition to the perimeter screening for parking, service, storage, or loading areas.
- Fences or masonry walls provide screening in tight spaces in combination with plant materials.
- Wide buffers and dense vegetation provide appropriate transitions on larger development projects. Existing landforms or created earth berms may be used in combination with plant materials for screening.
- Street trees and foundation plantings are used to give a residential appearance to a small office building.

## **Standards**

1. All buildings associated with a commercial or industrial development shall be appropriately landscaped. Fifty percent of a building façade is to contain foundation planting or a combination of architectural and landscaping treatment acceptable to the Office of Planning and Zoning. Such planting shall accentuate principal entrances, soften linear facades and generally improve building aesthetics. In instances where the building planting is also closely oriented to a parking area, the Office of Planning and Zoning may permit the material to be counted toward that required for parking and that required for the building.

## **E. SERVICE LANES**

### **Objectives**

- Screen service activities from all adjacent properties, and public and private roads.
- Landscape drive-thru service lanes and self-service storage facility service lanes adjacent to residential properties, and public and private roads, providing appropriate visibility for security and surveillance.
- Mitigate the noise, fumes, and light from intensive auto-related uses adjacent to residential properties.

### **Guidelines**

- Planting in combination with fencing or masonry walls provides maximum screening and visual interest.
- Groupings of screening materials combined with a formal hedge allow views into the site.
- Fences and/or walls shall be located on the inside edge of the required buffer. Planting shall be located on the street side of the fence.

## **Standards**

1. "Class A" 15' wide buffer with one Planting Unit per 15 linear feet of perimeter is required from all adjacent lot and lease lines to screen self-service storage facility service lanes and doors, drive-thru service lanes, stacking spaces, menu boards, and teller facilities adjacent to public rights-of-way.
2. If the minimum 15-foot landscape buffer is not feasible in redevelopment or commercial corridors, the buffer may be reduced to 7.5 feet with an opaque fence or wall and plantings on adjoined side of fence or wall with one Planting Unit per 20 linear feet of fence or wall. The height of the fence or wall should mitigate the impact from noise, fumes, and light on adjacent residences.

## **F. STORAGE, LOADING AND STAGING AREAS**

### **Objectives**

- Discourage the location of loading, storage, and staging areas adjacent to the road.
- Conceal loading, storage, and staging areas completely from all adjacent properties, and public and private roads.
- Separate noise-producing activities from residential uses.

### **Guidelines**

- Opaque planting screens storage and loading areas from public view and residential properties.
- Planting in combination with fences or masonry walls provides maximum screening.
- Storage and loading areas can be concealed within enclosures that are extensions of the building architecture with consistency of materials, color, and design.
- Sitting below grade or creating earth berms in conjunction with landscaping blocks undesirable views and mitigates noise impacts.
- Where permitted by building setbacks stipulated in Article 18, buildings should be located on the site to screen proposed parking from public right-of way and residential property (zone or use). Rear facades/loading docks should not face public right of way or residential properties, but if visible should be screened to mitigate visual impact.
- Interior planting areas for storage of boats, trucks, and vehicles in association with marinas, dealerships, contractor yards, etc., may be reduced or eliminated to accommodate storage and security needs dependent upon the size of the storage area and density of proposed perimeter screening.

### **Standards**

1. "Class B" buffer is required to screen loading, storage, and staging areas.
2. Screening of loading and outside storage areas between similar industrial uses is not required.

## **G. DUMPSTERS, MECHANICAL/ELECTRICAL EQUIPMENT & SIGNS**

### **Objectives**

- Conceal dumpsters from all adjacent properties and roads.
- Conceal ground-mounted air conditioning (HVAC) equipment areas (other than for single family residential units) from public view.

### **Guidelines**

- Evergreen plantings screen dumpsters and ground-mounted HVAC equipment from public view and residential properties.
- Trees and shrubs in combination with fencing or masonry walls provide maximum screening.
- Dumpsters can be concealed within enclosures that are extensions of the building architecture with consistency of materials, color, and design.
- Siting below grade or creating earth berms in conjunction with landscaping conceals HVAC units and other mechanical equipment from view.
- Avoid direct sight lines into dumpsters from entrance drives.
- A combination of shrubs and/or flowering and evergreen trees should be provided in and around the base of a freestanding identification sign to visually soften and anchor the sign to other related site improvements.

### **Standards**

1. "Class A" screening is required for dumpsters, trash corrals for multi-family dwellings, and ground-mounted mechanical/equipment. The linear feet of screening for the dumpster pad shall be measured along the perimeter of the two sides and rear. Screening shall be designed and located in a manner that does not impair sight distance at intersections.
2. Dumpster enclosures and trash corrals must be placed a minimum of 10 feet off rights-of-way and residential property lines.
3. Multiple dumpsters should be clustered (including dumpsters for recycling) and contained within permanent fenced or walled enclosures.
4. Dumpsters shall have operable front gates or wing walls where dumpster is visible from public road, entry drive, or adjacent residential property.
5. Free standing identification signs shall have a combination of shrubs and/or flowering and evergreen trees around the base to visually soften and anchor the sign to other related site improvements.

## **H. STORMWATER MANAGEMENT FACILITIES, INCLUDING BIO-RETENTION & RAIN GARDENS**

### **Objectives**

- Incorporate stormwater management and water quality facilities into the landscape setting.
- Treat stormwater management and water quality facilities as landscape amenities.
- All applicable landscaping areas are encouraged to be designed as Bioretention areas to accommodate stormwater management.
- Incorporate plant species that contribute to wildlife habitat and water quality attributes of stormwater management and water quality systems, (except as required by Federal and State guidelines for Airport Zones.)
- The use of ponds shall be minimized per the latest State and County Stormwater Management regulations. Utilize BMPs such as, but not limited to, Coastal Plain Outfalls, Bioretention, Infiltration and sand filter practices as much as possible.

### **Guidelines**

- Strategically placed plantings screen objectionable views of stormwater management riser structures.
- Informal or naturalistic tree and shrub masses blend pond slopes with surrounding landscape areas.
- Plantings of herbaceous perennial plant materials may be used to augment grassed dam embankments.
- Native plants enhance the wildlife habitat of the stormwater management or water quality facilities.
- Soften harsh embankments and integrate new landforms into the natural or project landscape.
- Refer to the latest State and County Stormwater Management regulations for planting requirements and guidelines.

## **I. SMALL BUSINESS DISTRICTS (SBD), DRIVE THRU AND FAST FOOD ESTABLISHMENTS**

### **Objectives**

- Ensure the compatibility of development in Small Business Districts with adjacent residential neighborhoods by providing appropriate transitions.
- Improve the appearance of the County's major commercial corridors and Commercial Revitalization Districts by enhanced design that complements residential character.

### **Guidelines**

- Walls in conjunction with planting define project boundaries and image.



- Planting in landscape strips between commercial lots provides shade and reduces the mass of paved areas.
- Front setbacks landscaped with lawn, canopy trees, ornamental trees, and foundation plantings give a residential appearance to the street.

## **Standards**

In addition to the Manual requirements for streetscape, parking lots, and commercial uses adjacent to residential uses, development in the Small Business Districts is subject to the following requirements:

1. Drive-thru banks, convenience stores, and fast food restaurants, as well as dumpster, service, and loading areas that are located adjacent to residentially used or zoned properties, shall provide a “Class B” buffer in the form of an earth berm, an opaque fence, a solid brick wall, or a wall built of architectural block, in combination with landscaping on both sides of the wall. All walls or fences shall be located at least 10 feet from the property line of the commercial use.
2. Provide a “Class A” buffer adjacent to nonresidential; 50% of the planting units shall be major trees.

## **J. RESIDENTIAL REAR AND SIDE YARDS ADJACENT TO ROADS**

### **Objectives**

- Enhance the public view of residential neighborhoods from adjacent roads.
- Screen public view of private yard space.
- Shield side yards of single-family attached and detached dwellings from the noise and visual impacts of roads.

### **Guidelines**

- If side frontage lots are unavoidable, earth berms and/or grade changes in combination with fencing/walls and plantings provide maximum screening
- A consistency of fence design and materials provides continuity along the streetscape. Offsets in the fence line combined with plant groupings reduce the monotony of long stretches of fencing.
- Open fence styles may be appropriate where greater setbacks allow room for informal landscape treatment.
- Plantings on the street side of solid screen wall/fence soften the wall and create maximum privacy and buffer from the street. Evergreen trees create solid buffers between private yard space and public and private roads.
- Side yard design should be incorporated into the project entry design.
- Where setbacks along arterials are increased, planting combined with berming provides effective screening.

## **Standards**

1. Screening of a dwelling unit is required where its side or rear lot line abuts a public right-of-way. The side yard to be screened is located between the front of the dwelling and the rear lot line. Screening shall comply with "Class D" requirements.
2. If fencing is provided or required, it must be set back 10 feet from the right-of-way in conjunction with trees and shrubs. A uniform style of fence architecturally compatible with the community style or home exterior is required. The required trees and shrubs shall be provided on the street side of the fence.
3. A graphic delineation of fencing shall be shown on Final Subdivision and Site Development Plans, and the location of fencing may not generally be closer than 10 feet to a public right-of-way.
4. Side frontage lots may be required to use a combination of grade change, fencing, and landscaping to screen rear yards.

## **K. RESIDENTIAL DEVELOPMENT ADJACENT TO FREEWAYS**

### **Objectives**

- Buffer residential dwellings from the noise and visual impacts of high intensity vehicular corridors.

### **Guidelines**

- Physical distance, berming, sound barrier walls, and vegetation are used to screen noise and visual impacts of such intensely traveled vehicular corridors.

### **Standards**

For dwellings located adjacent to an arterial or more intense road classification, a landscape area shall be provided in accordance with the following:

1. Planting quantities shall be calculated at double the "Class E" requirement.
2. Sound walls proposed for noise attenuation shall be located in a 25 foot buffer with planting on both sides of the wall.
3. A buffer containing an earth berm proposed for noise attenuation shall require planting on both sides of the berm.
4. A 50-foot landscaped common area owned and maintained by a homeowners association shall provide a visual screen if noise attenuation is not required. Existing woodland shall be retained where screening is required. Selective clearing or removal

of understory may be permitted to allow visibility into the subject site where appropriate. Existing vegetation that is retained but is not sufficient in width and square footage to meet the minimum forest retention requirements may be credited towards screening requirements. Such buffers shall be in addition to street trees.

5. The planting area can count towards Forest Conservation Act requirements if 35' wide and 10,000 square feet in size and that incorporate 100% native, non-invasive species.

## **L. RESIDENTIAL DEVELOPMENT ADJACENT TO SINGLE-FAMILY DWELLINGS**

### **Objectives**

- Provide a highly compatible transition or buffer between higher density residential use and lower density residential uses.
- Maintain development character.
- Define the boundaries between different density land uses.

### **Guidelines**

- The building landscaping provides a transition to the perimeter screening for adjoining lower density development.
- Fences or masonry walls provide screening in tight spaces in combination with plant materials.
- Wide buffers and dense vegetation provide appropriate transitions on larger development projects. Existing landforms or created earth berms may be used in combination with plant materials for screening

### **Standards**

In addition to the Manual requirements for streetscape, parking lots, and commercial uses adjacent to residential uses, residential development is subject to the following requirements:

1. Provide a "Class C" buffer for Multi-Family, Townhouse and Mobile Home development adjacent to single-family development.

## **M. RESIDENTIAL LANDSCAPING**

### **Objectives**

- Enhance the aesthetic appearance of neighborhoods by establishing a visual relationship between residential structures and their surrounding environments.

- Provide an element of privacy between neighbors.
- Conserve energy by reducing the energy needs of residential structures.

## Guidelines

- Relative location of trees should vary from lot to lot rather than the same design repeated many times within the same development.

## Standards

1. Townhouse and Single-Family Attached
  - a. Parking lots associated with single-family attached developments shall comply with buffer and interior planting standards as addressed here in.
  - b. In addition to the required parking plantings, each single-family attached development shall be planted with two additional shade trees for every dwelling unit. Minor deciduous or evergreen trees may be substituted at a rate of 2 to 1 up to 1/3 of the major shade tree requirements. Shade trees shall be of 2" caliper and 10 feet in height. Trees should be located on individual lots in a manner that provides shade for the dwelling or on community property and be, more or less, evenly distributed throughout the development.
2. Multi-Family Development
  - a. Parking lots associated with multi-family development shall comply with the buffer and interior planting standards as addressed herein.
  - b. In addition to the required parking plantings, each multi-family development shall be planted with one additional shade tree for every two dwelling units. Minor deciduous or evergreen trees may be substituted at a rate of 2 to 1 up to 1/3 of the major shade tree requirements. Shade trees shall be of 2" caliper and 10 feet in height. Trees should be located in a manner that provides shade for the dwellings or on community property and be, more or less, evenly distributed throughout the development.
  - c. Mid-rise and high-rise building sites located in a Commercial Revitalization District, a Town Center Zoning District, or within the Glen Burnie, Parole or Odenton Growth Management Areas may be allowed a reduction in the number of internal shade trees required. This reduction shall be authorized by the Planning and Zoning Officer to improve the correlation between the available green space the allowable density.
3. Mobile Home Parks
  - a. Mobile Home Parks shall be planted with one shade tree per unit. Shade trees may be located in the mobile home yard area on common areas of the park.

## **N. HISTORIC STRUCTURES AND AREAS**

### **Objectives**

- Preserve the setting and frame significant views of historic properties and unique scenery from the road.
- Buffer and screen historic structures from new development to separate incompatible uses visually and physically.
- Retain significant landscapes and vegetation associated with historic properties.

### **Guidelines**

- The structure(s) and setting of the historic property become the central organizational element of the development plan.
- Preservation of existing specimen trees, hedgerows, woods, and terrain contribute to the setting of the historic property.
- Evergreen trees create solid buffers between proposed developments and adjoining existing historic properties.
- Screening can be naturalistically designed if a formal hedge planting scheme is desired as appropriate to the site's historic context.
- The width of buffer and size of material will vary according to the screening objectives.

### **Standards**

1. A "Class A" buffer or supplemental planting may be required by the County Historic Sites Planner in concurrence with the Planning and Zoning Officer.

## **O. SCENIC AND HISTORIC ROADS**

### **Objectives**

Preserve and enhance the scenic resources identified in Article 17, the General Development Plan and Small Area Plans.

### **Guidelines**

- Plant materials frame vistas, views of landmarks, or focus views of special features of the landscape.
- Tree and vegetation removal is minimized to maintain enclosed views.
- Siting new development behind existing vegetation and beyond primary views or at the edges of hedgerows and woodlands minimizes visual impact.
- Earth berms and vegetative buffers screen views of new development.

## **Standards**

- Minimum standards can be found in Section IV, "General Standards", and in "Section V, "Screening Requirements". Recommendations for plantings beyond the minimum requirements will be site specific and made conditions of approval.

## **P. OPEN SPACE (PUBLICLY OR PRIVATELY OWNED)**

### **Objectives**

- Identify public space.
- Design open space to enhance the visual quality of the neighborhood or development.
- Provide a buffer from active recreation areas to residential rear or side yards.
- Enhance the comfort and sense of security of park users.

### **Guidelines**

- Landscape defines the edges of open space to differentiate common areas from private yard space and discourage encroachment. Maintaining good visibility from the street and nearby residences creates a sense of security and encourages use.
- The entry and special features of open spaces are defined by plantings and other landscape elements to create a sense of place.
- Plantings control pedestrian circulation while shade trees and benches provide comfortable areas for spectators and passive recreation users.
- The landscape treatment of adjacent roads is continued to define the edge of the open space.

### **Standards**

1. Landscape planting is applied to complement the function of the open space. Plant quantities are generated at one Planting Unit per 1500 sq. ft. of open space required. Credit may be given for retention of existing trees.
2. Standards for all applicable conditions apply.

## **Q. RECREATIONAL FACILITIES**

### **Objectives**

- Provide amenities for employees, shoppers, residents of high-density multifamily housing, and the public to enjoy outdoor recreation and leisure activities.

## **Guidelines**

- Spaces adjacent to building entrances and between groups of buildings are developed as plazas, courtyards, and landscaped walkways integrated within the overall pedestrian system.
- An overlook with tables, seating areas, and decorative lighting is located to take advantage of viewing natural landscapes.

## **Standards**

1. To be credited as required recreation area open space by the Office of Planning and Zoning, plazas, parks and other open areas shall be designated with hardscape and green areas for use by the public.
2. Placement of plant materials shall conform to the guidelines and objectives of this Manual, the Odenton Town Center Master Plan and the Parole Urban Design Concept Plan.
5. "Class A" screening shall be provided for active recreation areas adjacent to residential uses.

**VI. PLAN, PREPARATION, REVIEW AND APPROVAL**



## **Plan Preparation, Review, and Approval**

All landscape plans other than for individual single family detached lots, shall be prepared, signed, and sealed by a registered landscape architect. The County may permit an individual with a minimum of six years experience in landscape design or equivalent education and experience to prepare landscape plans if sufficient documentation is provided prior to application.

Landscape plans are prepared in stages with increasing levels of detail, culminating in a plan ready for installation by the landscape contractor. The landscape plan stages described below as Concept Landscape Plan and Final Landscape Plan represent levels of refinement that are relative to the applicable development process.

Development that is required to submit a Preliminary Plan, Sketch Plan, Variance or Special Exception (subject to the County Code) must include the Concept Landscape Plan for the site.

### **A. CONCEPT LANDSCAPE PLAN (FOR PRELIMINARY PLANS, SKETCH PLANS, VARIANCES, SPECIAL EXCEPTIONS)**

The landscape concept is a simplified graphic representation of the combination of landscape elements proposed for the development. The elements should be selected to satisfy the standards and objectives of the Manual, relevant community plans or revitalization plans, and guidelines of the General Development Plan and Small Area Plans. The Concept Landscape Plan shall demonstrate the purpose and function of the landscaping, buffer widths, the general location of planting units, and the suggested screening method or plant materials.

1. The Concept Landscape Plan is to be shown on the preliminary plan, sketch plan, special exception plan or variance plan and not on a separate plan. The depiction of the various landscape elements, trees, hedges, etc., should be simple in form and understandable to the layperson. The concept should include existing vegetation to be preserved or removed, proposed areas of screening, buffering, berming, use of street trees, proposed landscape areas, landscape amenities, and any other landscape elements anticipated to be incorporated into the Site Development Plan or Final Subdivision Landscape Plans.
2. The Office of Planning and Zoning shall review the Concept Landscape Plan and comment on the proposed landscape elements in relation to the standards and objectives of the Manual, relevant community plans or revitalization plans, and guidelines of the General Development Plan and Small Area Plans
3. If a development uses the optional planned unit development (PUD) process, the Concept Landscape Plan, must also indicate the type and quality of all landscape elements with a higher degree of resolution to site design issues. Prepare sections, elevations and perspectives coordinated with the landscape plan, that demonstrate the quality and intensity of the design and materials. These are included as part of the architectural drawings for a PUD. The plan and

drawings must show the arrangement of landscape materials, and their integration with site features such as walks, grading, structures, etc.

4. In addition to the guidelines of this Manual, other County guidelines for PUDs, and appropriate County guidelines for residential, office and commercial development shall be followed. Landscape requirements for PUDs shall exceed the minimum requirements of this Manual.
5. The Office of Planning and Zoning will require that a submitted Concept Landscape Plan is signed and sealed by a registered landscape architect.

**B. FINAL LANDSCAPE PLAN (FINAL PLAN OF SUBDIVISION OR SITE DEVELOPMENT PLAN)**

1. The Final Landscape Plan shall be consistent with the provisions of this Manual and any conditions attached to a Subdivision or Site Development Plan, Hearing Officer's order, special exception, special hearing, variance, or board of appeals opinion.
2. The plan shall show all applicable items indicated on the Concept Landscape Plan Checklist and the additional items required on the Final Landscape Plan Checklist. Landscape Plan checklists are available on the Anne Arundel County website.
3. The Final Landscape Plan shall include a plant list and unit costs to be used as the approved cost estimate for security/bonding. Submit an itemized cost estimate with the plan that includes the cost of required plant materials and architectural elements such as fences and masonry walls. (See Appendix K, Cost Estimates)
4. The Final Landscape Plan must be approved and secured (along with 7% inspection fee, when required) before grading and/or building permits may be issued.

**C. Implementation of Final Landscape Plan**

**1. Security**

If security is required, it shall be posted as part of the Grading Permit bond or if no grading permit is required, a separate landscape agreement shall be executed with security acceptable to the County. The Director of Inspections and Permits will determine release of partial or full security subject to the following criteria.

- a. On approval of the landscape plan and cost estimate by the County, the applicant shall post security as part of the grading permit bond.
- b. Security shall be in the amount of the cost estimate and in a form acceptable to the County Attorney and the Finance Officer.

- c. All planting shall be in accordance with the "Landscape Specifications Guidelines for the Baltimore-Washington Metropolitan Area," as published by the Landscape Contractors Association of Washington unless otherwise specified within this Manual.
- d. All planting and screening shall be installed within one year of the date that the landscape agreement is executed.
- e. If installation cannot be accomplished due to seasonal planting requirements or construction time frames, the Director may grant an extension of no more than six months.
- f. If an applicant fails to complete the planting and screening in a timely fashion in accordance with the Landscape Agreement and the requirements of this title and the Landscape Manual, the security shall be forfeited.
- g. If the County's costs in completing the work under the Landscape Plan are greater than the amount of security, the excess costs shall constitute a lien on the property.
- h. Notwithstanding any other provision of this section, a public utility franchised in the county may submit a letter of guarantee, instead of the Landscape Agreement and security, in a form approved by the County Attorney.

## **2. Release of Security**

- a. On inspection by the Department of Inspections and Permits, up to 50% of that portion of the security that covers the plant material may be released, and the remaining bond shall be retained for one year to ensure replacement of dead or damaged plant material.
- b. The Landscape Agreement may provide for a full release of that portion of the security that covers non-plant materials and screening improvements.

## **3. Installation**

- a. Landscaping shall be installed on any lot within three (3) months of issuance of an occupancy permit for the building on that lot. This may be extended as a result of good cause shown in accordance with conditions imposed by the County and presented to the Director of Inspections and Permits. The County shall enforce and seek installation or the correction of the required landscaping pursuant to the remedies provided by law.

## **4. Compliance**

- a. Compliance shall be verified at time of final inspection. The developer is responsible for the submittal of a red line, as-built landscape plan if required by the County to note any modifications

## **5. Warranty**

- a. Installed landscaping shall be guaranteed to be in a viable, thriving condition by the developer for a minimum of one year after final inspection and acceptance of the work by Anne Arundel County. Plant material that is not thriving and in

viable condition after this time period shall be replaced at the original planted size.

- b. Applicant shall replace plant materials or correct improvements if the plant materials or improvements violate the Landscape Plan; fail to satisfy the requirements of this Manual or the "Landscape Specifications Guidelines for the Baltimore-Washington Metropolitan Area," as published by the Landscape Contractors Association of Washington; or if the planting is in failing health.

## **6. Maintenance**

- a. After the Director of Inspections and Permits has determined that the obligations of the Final Landscape Plan have been fulfilled and are in compliance, the developer shall be released from responsibility in accordance with the requirements of the County Code.
- b. The owner and occupant of property are jointly responsible for:
  - i. Maintaining landscaping in a healthy condition;
  - ii. Maintaining plant materials and non-plant materials in a sound and neat condition; and
  - iii. Keeping landscaped areas free of refuse and debris.

## **7. Enforcement**

- a. The County shall enforce the provisions of this Manual. In addition to any other remedy allowed by law, the County may enforce and seek the correction of a violation of this Manual.

## **8. Inspection**

- a. The County shall perform an initial inspection of all plant material and nonplant improvements immediately after installation and a final inspection approximately one year later. An applicant shall request each inspection.
- b. Instead of the initial inspection being performed by the County, an applicant may submit a notarized affidavit from the Landscape Architecture firm that designed the approved plans or from an individual qualified to prepare a landscape plan as provided by the Landscape Manual, verifying that all adequate soil preparation and required landscaping installation is in compliance with the County guidelines.
- c. An applicant shall pay a fee at the time of application for both inspections of 7% of the value of the installed plant materials and non-plant improvements, with a maximum fee of \$1,000. If an applicant certifies that the initial inspection will be made by a qualified individual as provided in subsection (B) of this section, the inspection fee may be reduced by 50% at the time of payment.
- d. Security posted by the applicant shall be forfeited if the applicant fails to request an inspection; or fails to have an inspection made after certifying that a qualified individual will make a final inspection.
- e. If additional inspections are required because an applicant has not made a good faith effort to complete the work under the Landscape Agreement, the applicant shall pay an additional fee for each inspection made by the department. The additional fee shall be in the amount of 3.5% of the value of the installed plant materials and non-plant improvements with a maximum fee of \$1,000.

## **VII. APPENDICES**

## APPENDIX 'A': Definitions

Berm - An earthen mound designed to provide visual interest on a site, screen undesirable views and noise reduction.

Buffer - A combination of physical space and vertical elements, such as plants, berms, fences, or walls, the purpose of which is to separate and screen incompatible land uses from each other.

Critical Root Zone – a circular region measured outward from a tree trunk representing the essential area of the roots that must be maintained or protected for the tree's survival; for the purpose of this Manual, critical root zone is one foot of radial distance for every inch of tree diameter (DBH) measured at 4.5 feet from the ground, with a minimum of 8 feet. For specimen trees the formula changes to 1.5 feet for every inch of tree diameter (DBH).

Deciduous - A plant with foliage that is shed annually.

Forest – a biological community dominated by trees and other woody plants covering a land area of 10,000 square feet or greater. Forest includes (1) areas that have at least 100 trees per acre with at least 50% of those having a two-inch or greater diameter at 4.5 feet above the ground and larger, and (2) forest areas that have been cut but not cleared. Forest does not include orchards.

Evergreen – a plant with foliage that persists and remains green year-round.

Herbaceous Perennial – plant persisting for several years, usually with new herbaceous leaf growth each year.

Institutional Development – those uses that serve a recreational, social, medical, educational, or religious purpose, such as schools, nursing homes, assisted living facilities, hospitals, libraries, museums, and nonprofit charitable or philanthropic organizations.

Landscape Plan - a plan, drawn to scale, showing dimensions and detail for onsite improvements including planting, landscape and site amenities. The Plan shows existing vegetation, environmental features, utilities, topography, and the name, location, quantity, size, type, and cost of proposed plant materials.

Ornamental Tree – a deciduous tree planted primarily for its ornamental value, or for screening. Generally does not exceed a height of 40 feet and will tend to flower.

Planting Soil Mix – a prepared soil mix used for planting medium as described in Appendix E.

Screening – a method of reducing the impact of visual and/or noise intrusions through the use of plant materials, berms, fences and/or walls, or any combination thereof. Screening blocks that which is unsightly or offensive with a more harmonious element.

Shade Tree – a deciduous (or rarely, an evergreen) tree planted primarily for its high crown of foliage or overhead canopy. A major shade tree at maturity reaches a height of at least 70 feet. A minor shade tree generally does not exceed a height of 40 feet.

Shrub – a woody plant, smaller than a tree, which consists of a number of small stems from the ground or small branches near the ground. May be deciduous or evergreen.

Soil Amendments – the modification of soil properties for improvement of soil structure; not to be confused with fertilizers whose purpose is to correct chemical imbalances for silvicultural purposes.

Specimen Tree – a particularly impressive or unusual example of a species due to its size, shape, age, or any other trait that epitomizes the character of the species. The diameter (DBH) measured at 4.5 feet above the ground is 30 inches or more.

Street Tree – a tree planted in close proximity to a street in order to provide canopy over the street, to give the street a sense of spatial definition and human scale, to provide shade, and soften the street environment.

Temporary Tree Protection Devices – structural measures such as fencing or bioretention installed prior to construction for the purpose of preventing access to forest retention areas or afforestation areas during construction.

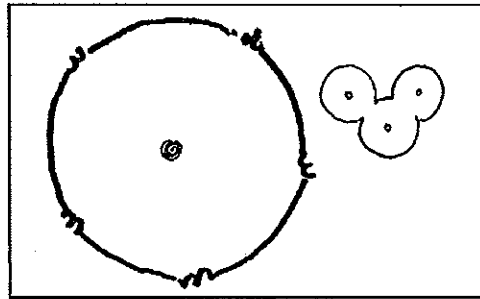
Woodlands, Existing – existing trees and shrubs of a number, size and type that approximately accomplish the same function as new plantings.

## **APPENDIX 'B': Exhibits 1-9**

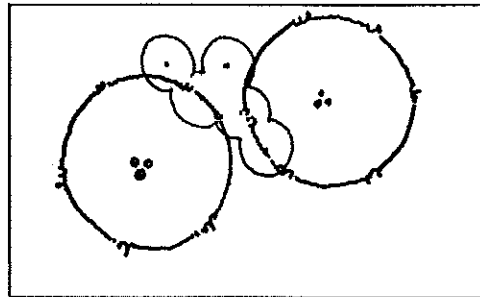


EXHIBIT 1

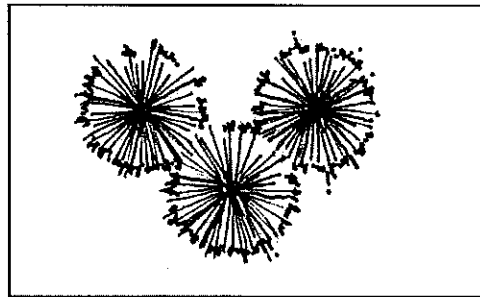
**Planting Unit Detail (Typical)**



1 SHADE TREE  
3 SHRUBS



2 MINOR DECIDUOUS TREES  
5 SHRUBS



3 EVERGREEN TREES

EXHIBIT 2

**Site Perimeter Buffer Requirements (Typical)**

Class 'A'

Class 'B'

Class 'C'

Class 'D'

Class 'E'

# Exhibit 2: Class A

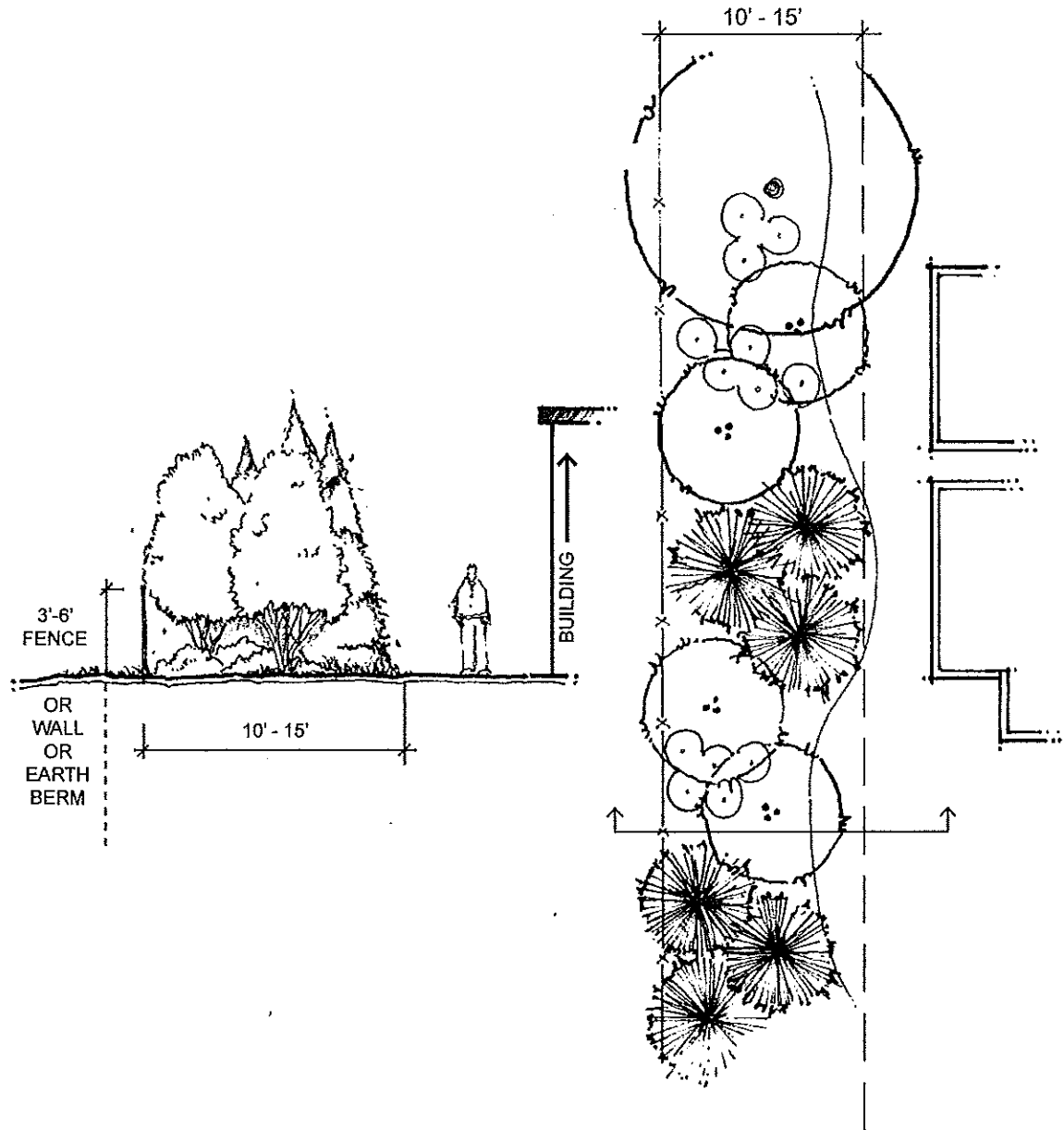


Exhibit 2: Class B

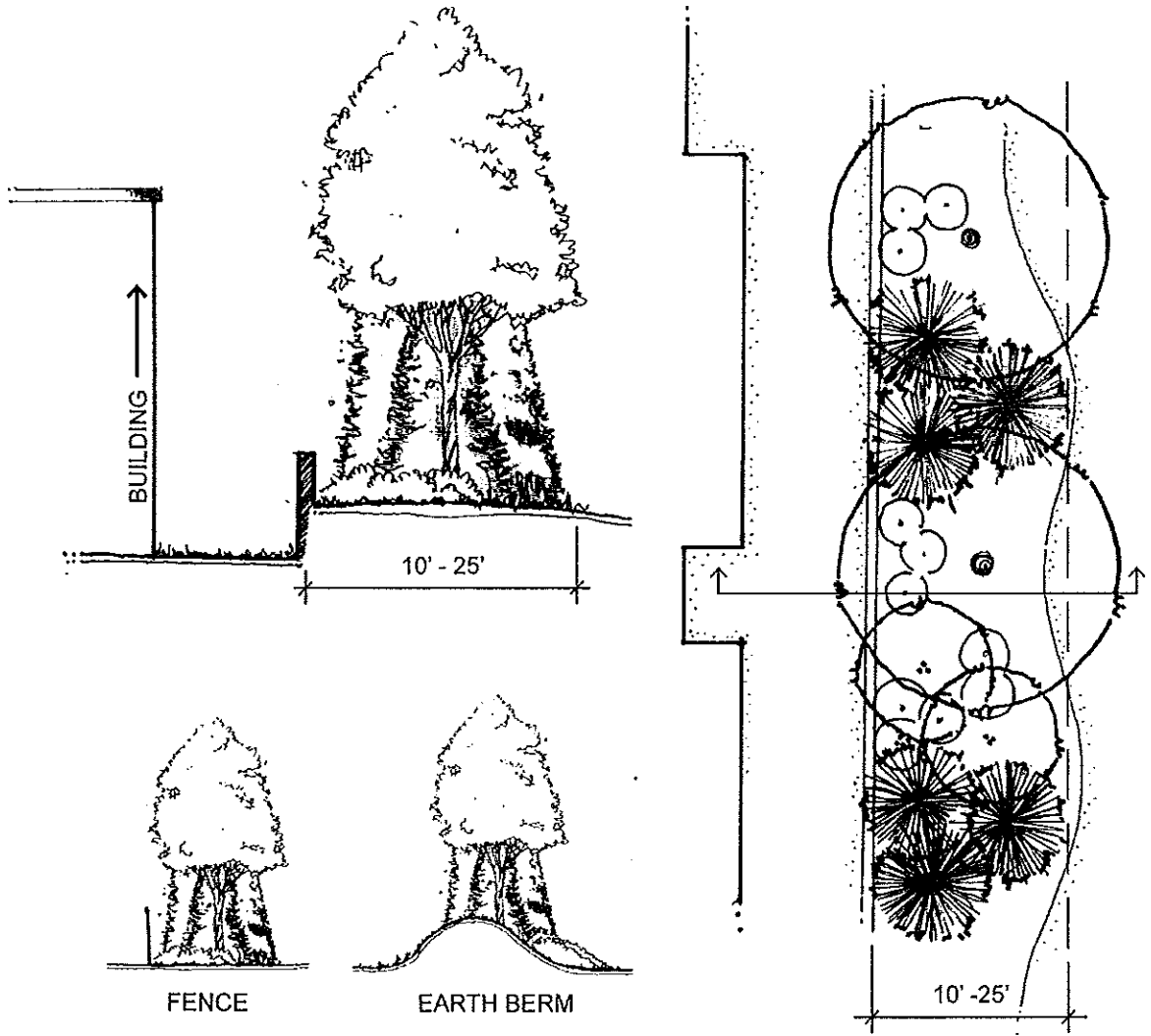


Exhibit 2: Class C

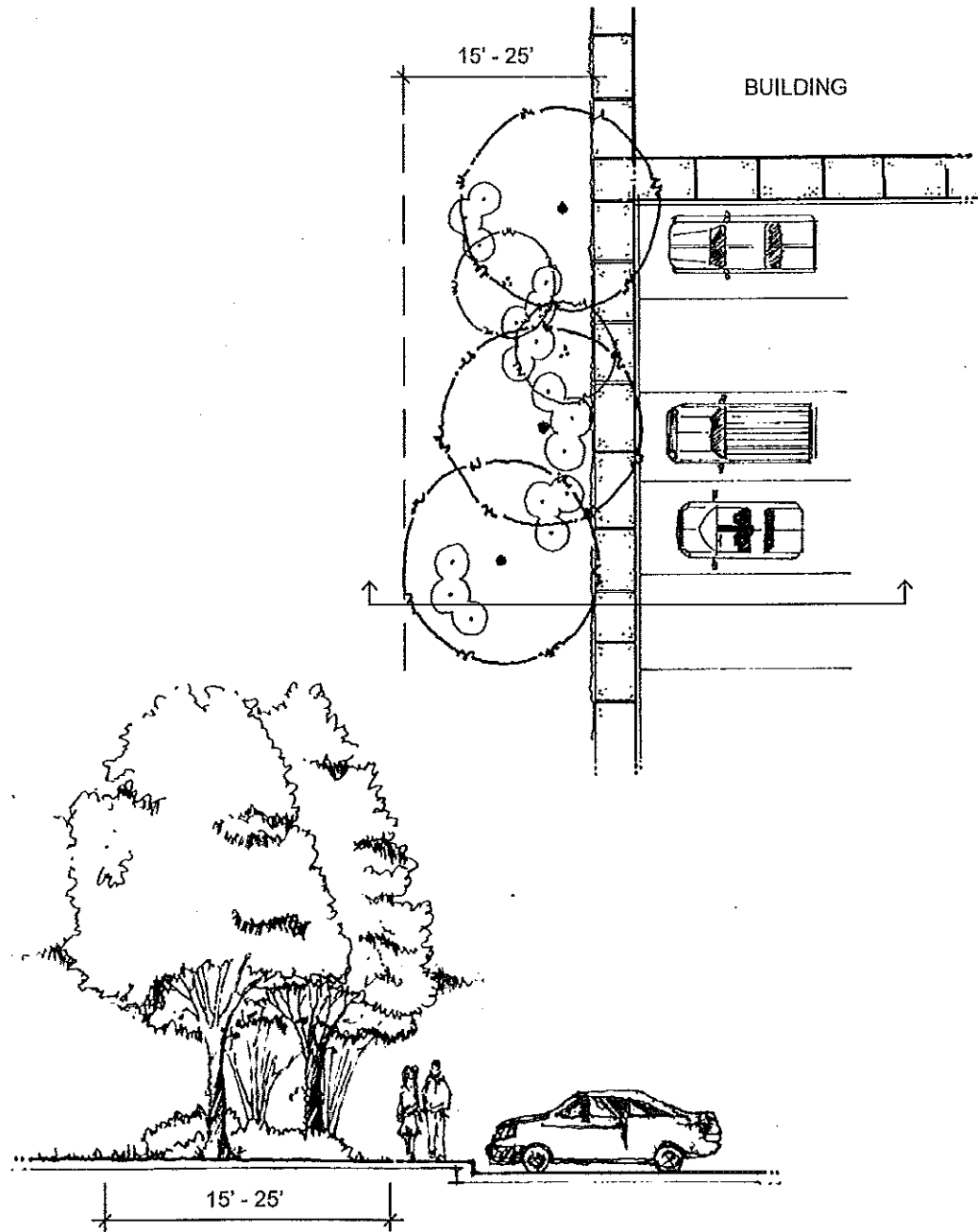
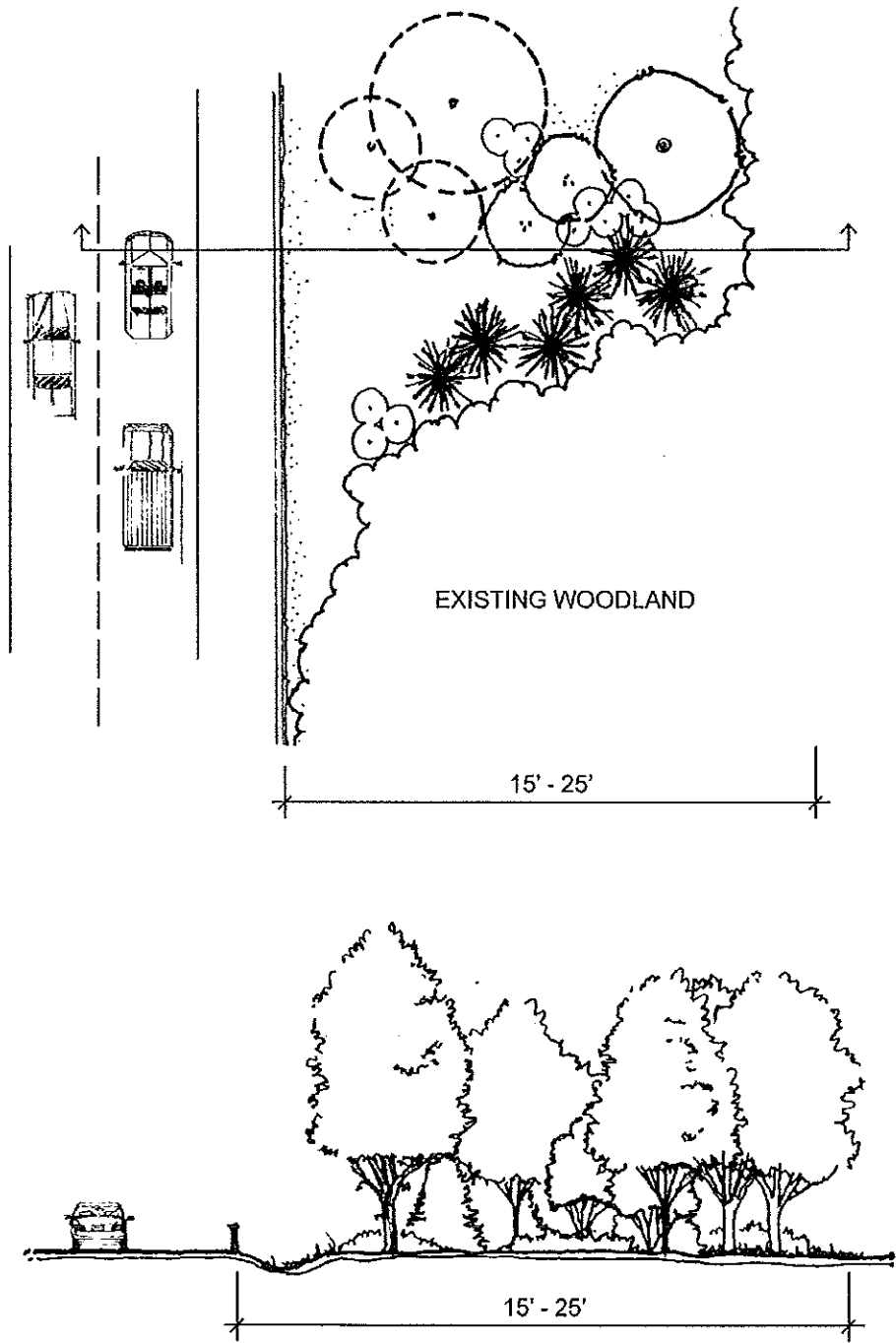


Exhibit 2: Class D



**Exhibit 2: Class E**

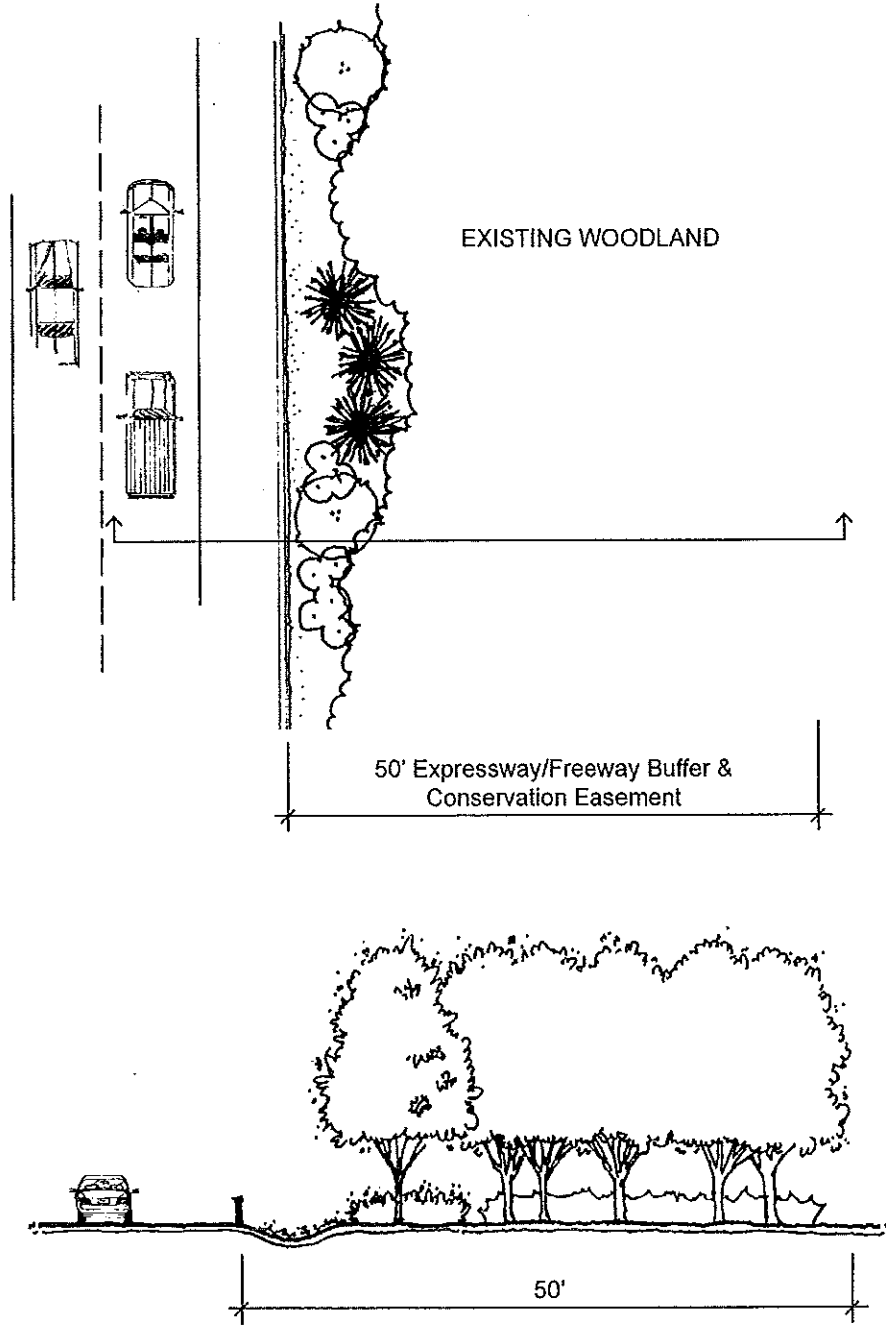
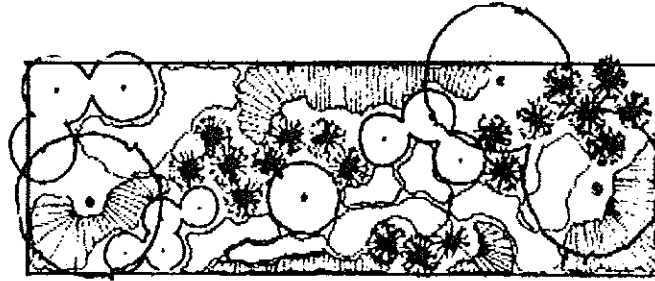
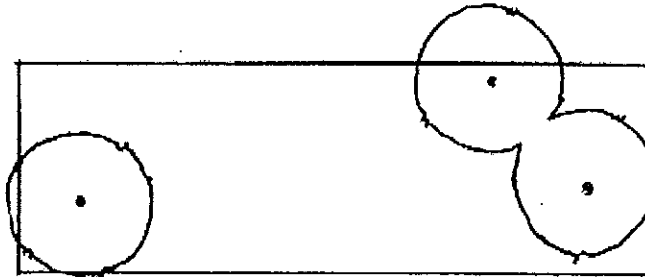


EXHIBIT 3

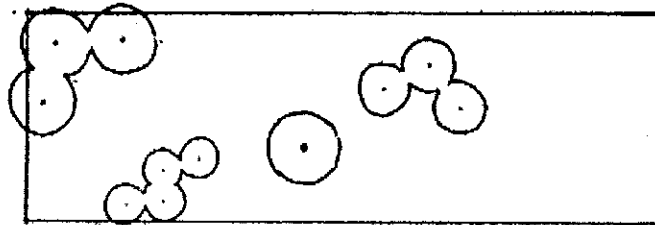
Buffer Planting Composition (Typical)



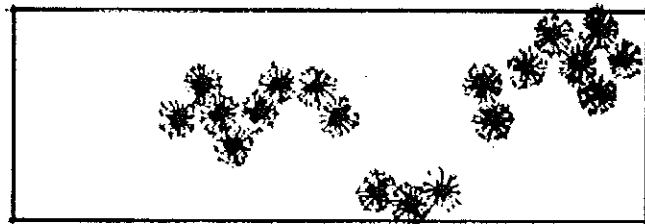
COMPLETE COMPOSITION



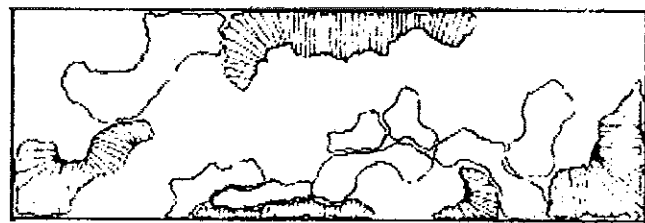
TREES



DECIDUOUS SHRUBS



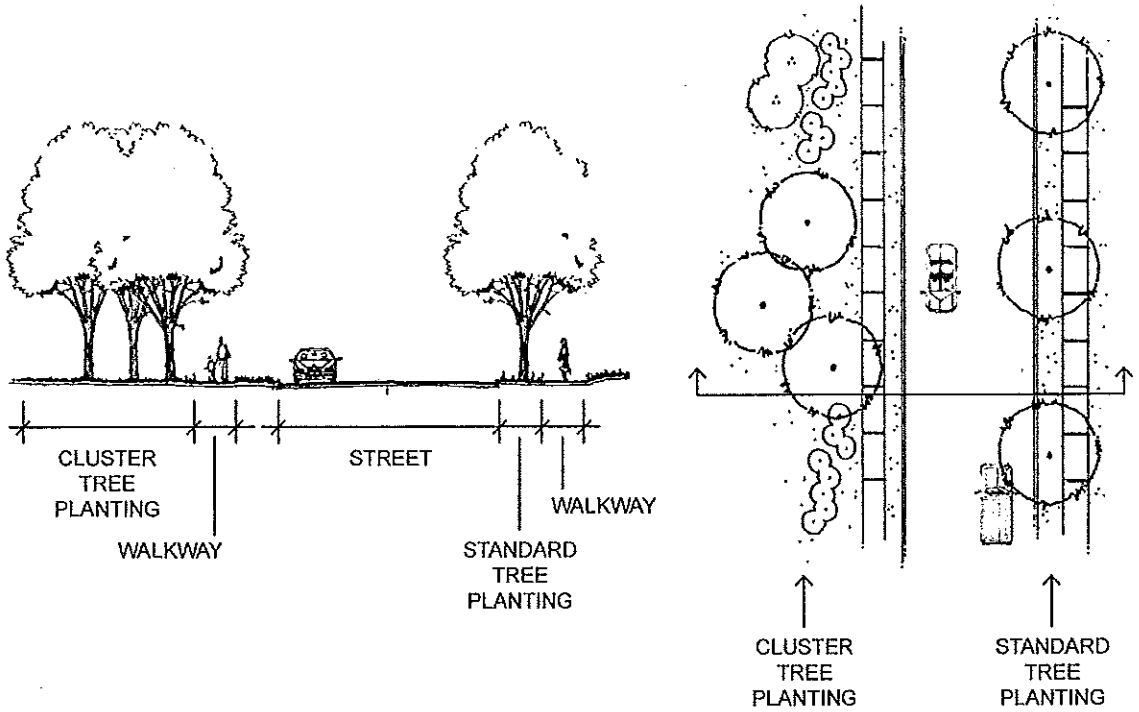
EVERGREEN SHRUBS



PERENNIALS AND GROUNDCOVERS



EXHIBIT 4  
**Street Tree Design**



**Street Trees and Plantings**  
**Adjacent to Utility/Road Right-of-Way**

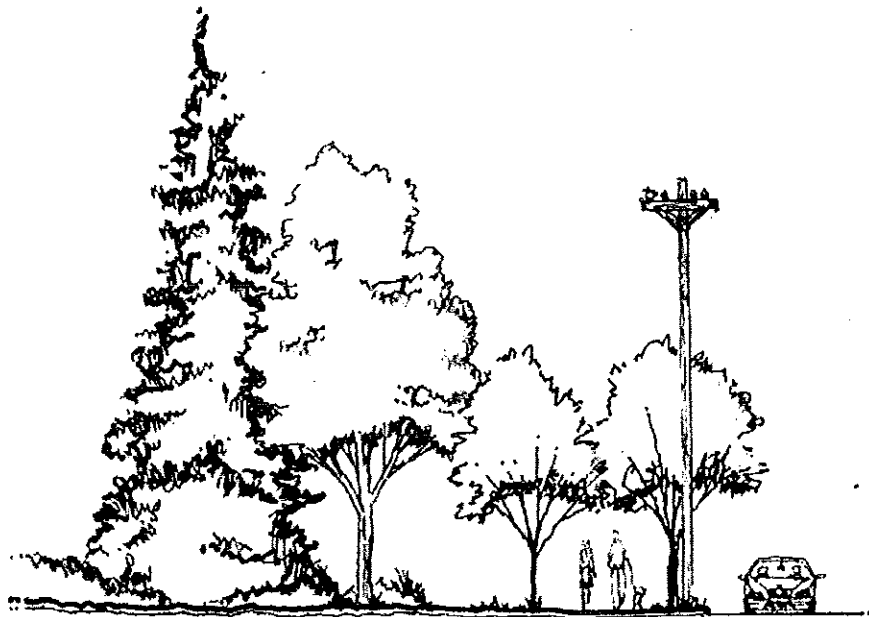


EXHIBIT 5

# Urban Streetscape Design

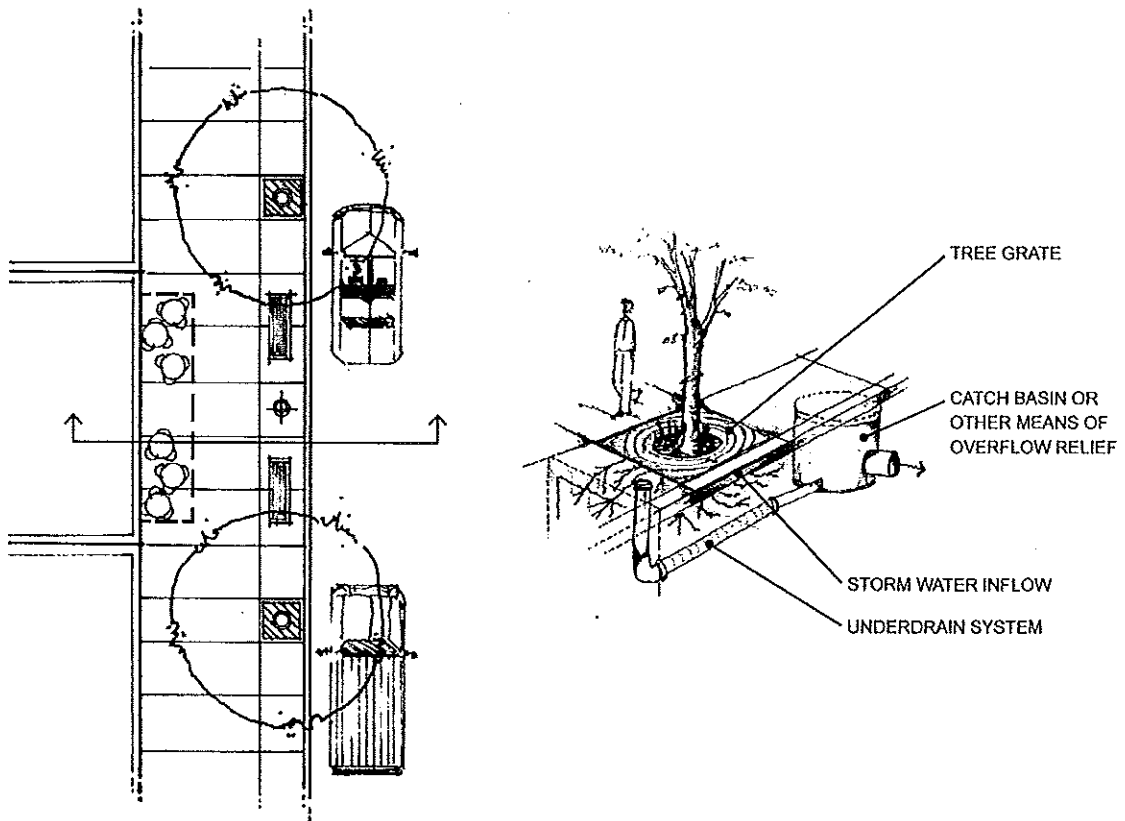
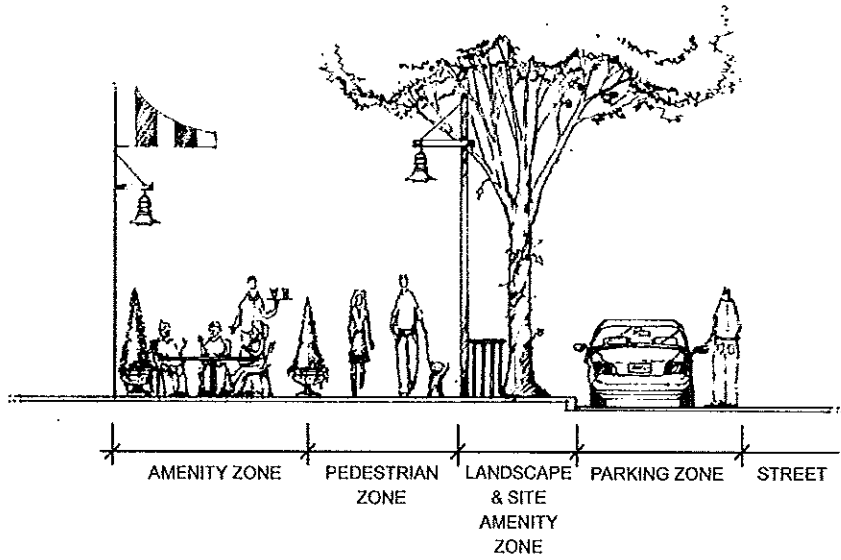


EXHIBIT 6

## Tree/Sign/Light Pole Placement

Street trees which are placed behind sidewalk on closed section roads or at least eight feet from the edge of paving on open section roads usually do not obstruct sight distance and are generally not subject to these restrictions. However, a case by case review may be necessary depending on the species of tree used.

In order to assure adequate visibility of signs and vehicles, and to prevent the blocking of street lights, street trees shall not be placed:

- Within 100 feet of the face of a STOP or YIELD sign;
- Within 50 feet of the face of any other street sign;
- Within 25 feet of a street light; or
- Within 150 feet of the intersection to the left or within 100 feet of the intersection to the right along a cross street at an intersection controlled by a STOP or YIELD sign.

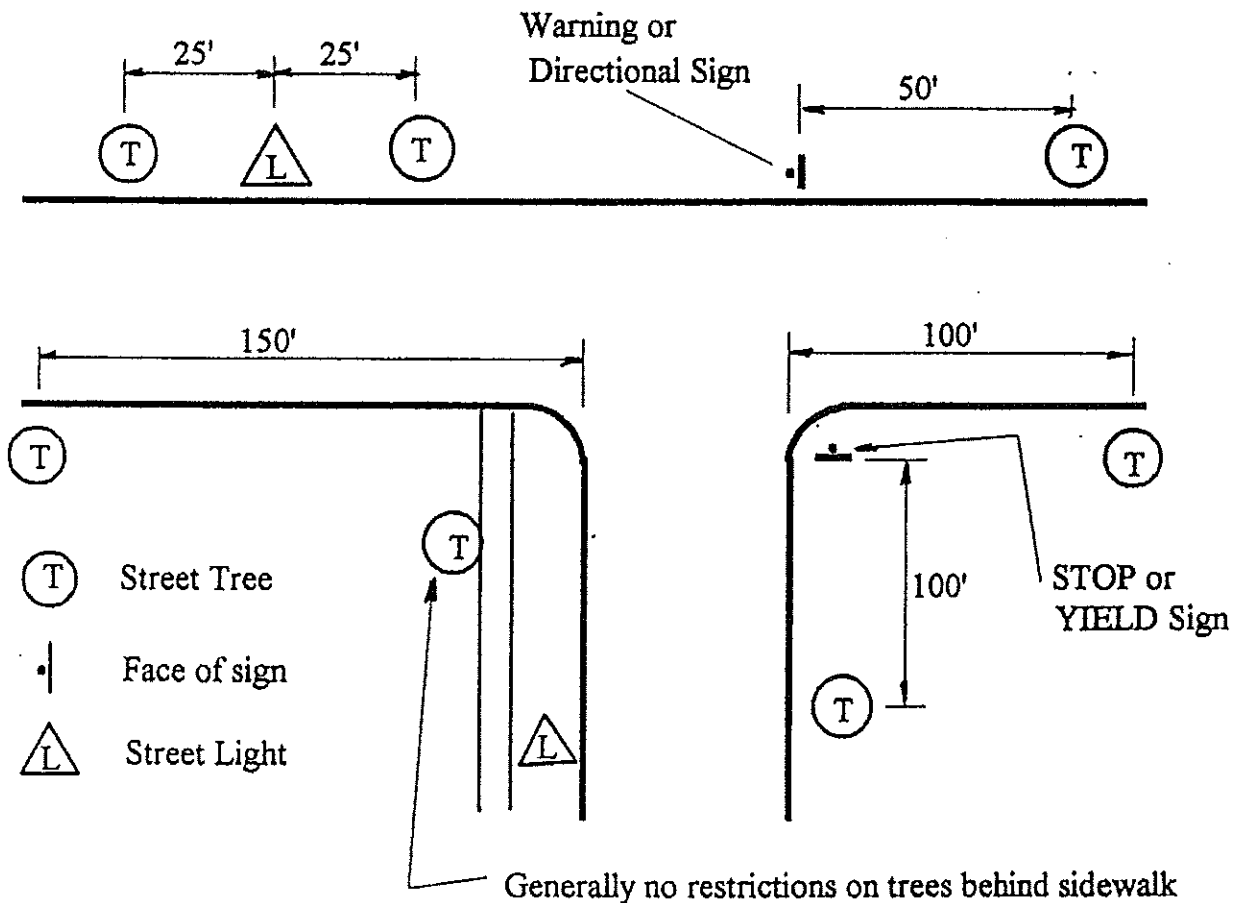


EXHIBIT 7

Sight Triangle

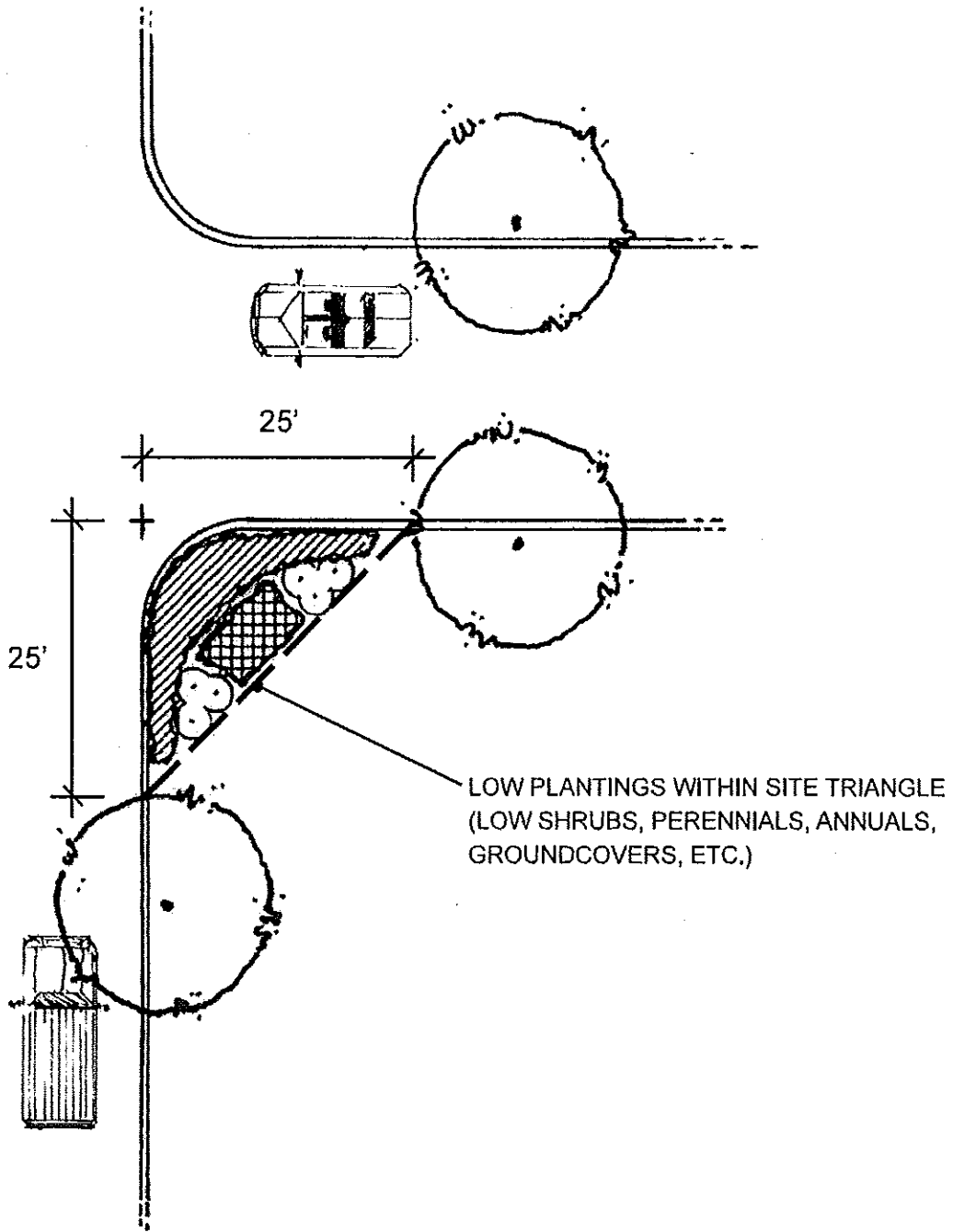
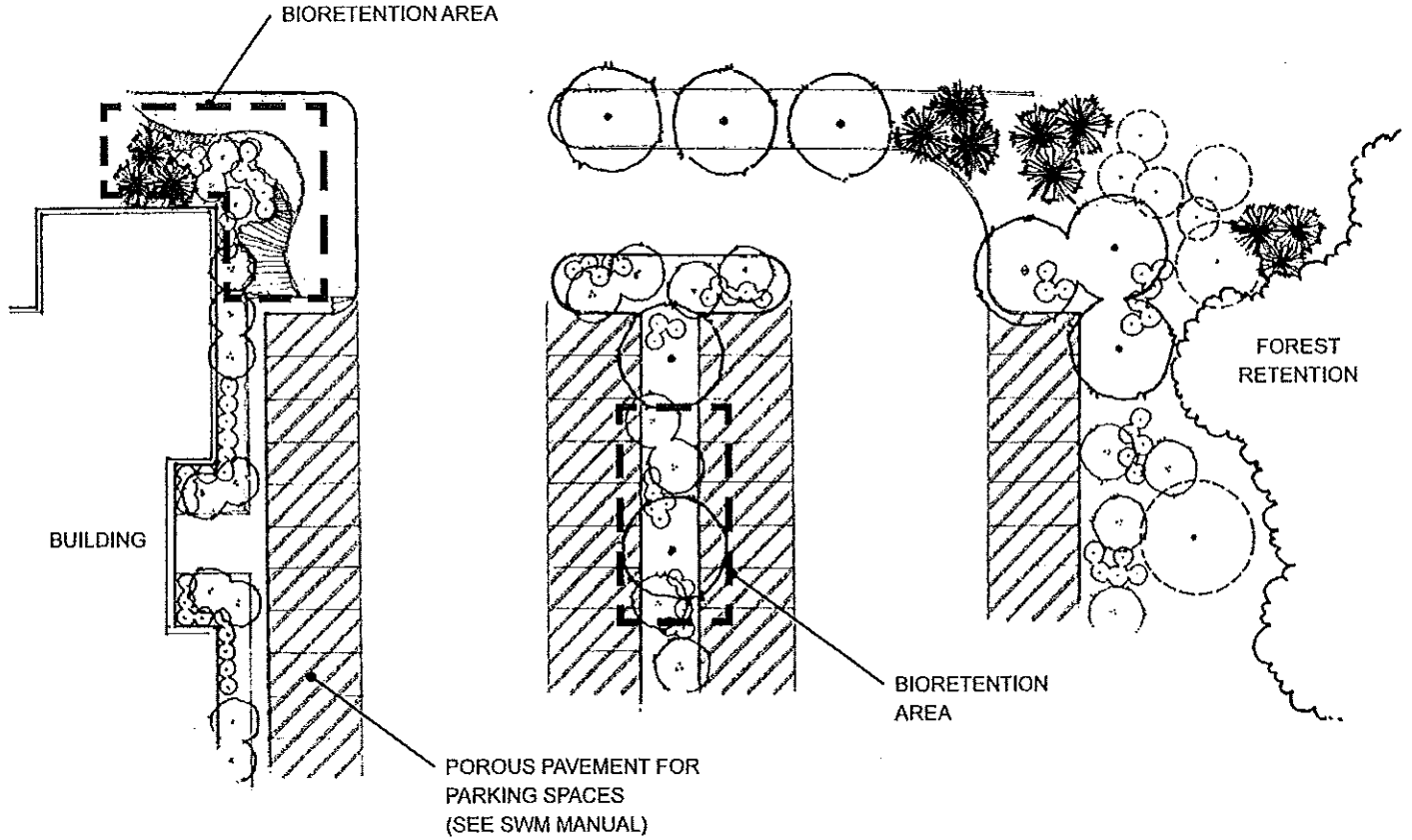


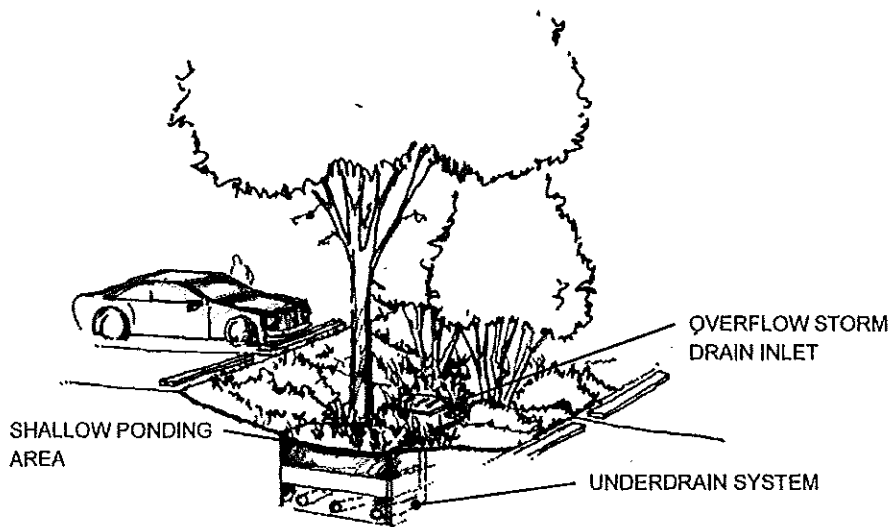
EXHIBIT 8

Interior Green Space Plantings



BIORETENTION MEDIAN EXAMPLE

NOTE: REQUIRED LANDSCAPE AREAS MAY BE USED FOR BIORETENTION



**EXHIBIT 9**

**Tree and Planting Detail**

**(See Storm Water Management Manual)**

# APPENDIX 'C': Planting Species Specifications & Requirements

## 1. Plant Materials

- a. The landscape contractor shall furnish and install and/or dig, ball, burlap and transplant all of the plant materials called for on the drawings and/or listed in the Plant Schedule.
- b. Plant names used in the Plant Schedule shall be identified in accordance with Hortus Third, by L.H. Bailey, 1976.

## 2. Plant Standards

- a. Species shall be selected that will not cause injury to property users, will grow to a size consistent with their intended use, (screening, shade, etc.) and thrive in the locations where they are being planted. Plants shall not block or interfere with walkway areas or designated view lines into or out of the site for safety reasons.
- b. Species that are known to be invasive should be avoided, especially on properties close to or abutting natural or sensitive areas. Plants susceptible to breakage due to weak structure or known to be extremely susceptible to pests and diseases in this area shall not be used.
- c. Tree species shall be selected that will survive in the closed soil condition of habit consistent with their placement.
- d. All plant materials shall be equal to or better than the requirements of the "American Standard for Nursery Stock," latest edition, as published by the American Association of Nurserymen (hereafter referred to as AAN Standards). All plants shall be typical of their species and variety, shall have a normal habit of growth and shall be first quality, sound, vigorous, well-branched and with healthy, well-furnished root systems. They shall be free of disease, insect pests and mechanical injuries.
- e. All plants shall be nursery grown and shall have been grown under the same climatic conditions as the location of this project for at least two years before planting. Neither heeled-in plants nor plants from cold storage will be accepted.
- f. Collected plants or transplanted trees may be called for by the landscape architect and used, provided, however, that locations and soil conditions will permit proper balling.

## 3. Deciduous Shade Trees

- a. Size: 2 – 2 ½ inch caliper  
Minimum clear branch height: 7 feet in areas of pedestrian or vehicular circulation
- b. Surface rooted trees shall not be used in closed soil conditions or within 10 ft. of pavement areas.
- c. Trees that may only be used in a reforestation or large area condition: Eastern Black Walnut, Black Locust, Tulip Poplar, Weeping Willow, Box Elder, Silver Maple.

4. Ornamental Trees
  - a. Size: 1 1/2 - 1 3/4 inch caliper
  - b. Spacing: To be consistent with species and use
  
5. Evergreen Trees
  - a. Size: 6 ft. height
  - b. Spacing: To be consistent with species and use
  
6. Shrubs
  - a. Size: 24-36 inches in height at installation
  - b. No bare root plants or sizes less than 1 gallon container size will be accepted, other than for reforestation purposes.
  - c. Spacing: Plants shall be spaced for continuous planting or required screening.
  
7. Groundcovers, Vines, Perennials, Ornamental Grasses
  - a. Size to be consistent with intended use.
  - b. No bare root plants are to be used. Minimum size of woody species or grasses shall be 24 inches in height in one-gallon container; minimum size of perennials, vines and other grasses is one quart.
  - c. Herbaceous groundcovers, (Pachysandra, Vinca, etc.) may be provided in 2 inch pots or flats.
  - d. Spacing: Groundcovers shall be spaced to provide continuous coverage within 3 years after planting.
  
8. Planting Seasons
  - a. A professional horticulturalist/nurseryman shall be consulted to determine the proper time, based on plant species and weather conditions, to move and install particular plant material and to minimize stress to the plant.
  
9. Digging
  - a. All plant material shall be dug, balled and burlapped or bare root in accordance with the "AAN Standards."
  
10. Excavation of Plant Pits
  - a. All pits shall be generally circular in outline, and the tree deep enough to allow 1/8 of the ball to be above the existing grade. Plants shall rest on undisturbed existing soil or well-compacted backfill.
  - b. Areas designated as shrub beds shall be cultivated to at least 18 inches depth minimum. Areas designated for herbaceous perennials, ground covers, and vines shall be cultivated to at least 12 inches in depth minimum.
  
11. Plant Pruning, Edging and Mulching
  - a. Plant material shall be pruned in an appropriate manner to its particular requirements, in accordance with accepted standard practice. Broken or bruised branches shall be removed with clean cuts made on an angle from the bark ridge to the branch collar, no flush cuts, to minimize the area cut. All cuts shall be made with sharp tools. Trim all edges smooth. No tree wound dressings shall be applied.



12. Seeding and Sodding

- a. All seeding and sodding shall be as per "Standards and Specifications for Soil Erosion and Sediment Control in Urbanizing Areas" as published by the Maryland Department of Natural Resources except as noted below:
- b. Areas between building facades and paved surfaces shall be seeded or sodded with a mixture of three varieties of improved fall fescue at 3-4 pounds/1000 sq. ft.

# APPENDIX 'D': Planting Soil Guidelines

## 1. Planting Soil Improvement Requirements

(Plan to be provided by Landscape Architect)

## 2. Drainage Improvement Requirements

The following requirements apply to both planting soil and subgrade soil that supports planting soil:

- a. Well drained Soil: No requirements
- b. Moderately drained soil: Minimum 5% slopes in all tree and shrub planting areas.
- c. Poorly drained soil: Minimum 5% slopes in all tree and shrub planting areas. Add subsurface drainage lines along the low points of all subgrades. Drain line inverts shall be no less than 18 inches below the finished surface or 6 inches below the required planting soil improvement whichever is greater. For planting bed areas 300 sq feet or greater in area, space subsurface drainage lines no more than 15 feet on center. Within areas that slope greater than 8%, drain lines shall only be required along the lower edge of the planting bed.
- d. Lawn areas within 15 feet of the trunk of any required tree areas shall conform to slope requirements.

## 3. Definitions

- a. Loam soil: Soil with less than 35% clay; 50% silt; 85% sand or 15% gravel within Unified Soil Classifications SM, SC, ML, CL, O. Organic content greater than 2% but less than 8% by weight.
- b. Good Soil: Loam soil with less than 12 inches of fill or 6 inches of cut from the original grade. The soil profile shall have an organic A horizon. In fill areas the A horizon shall be undisturbed. In cut areas the B horizon shall be undisturbed. Bulk density less than the amount defined herein as restricting root penetration. (Refer to Table 1-Bulk Density, below.)
- c. Graded soil: Loam soil where more than 12 inches of loam soil fill has been added or more than 6 inches of cut has been stripped. Remaining soil in the fill area shall be loam soil. Soil shall not have become compacted to a bulk density greater than the amount defined herein as restricting root penetration.
- d. Compacted soil: Loam soil with less than 12 inches of fill or 6 inches of cut from the original grade. A horizon in fill areas is undisturbed. Bulk density more than the amount defined herein as restricting root penetration.
- e. Graded and compacted: Loam soil where more than 12 inches of fill has been added or more than 6 inches of cut has been stripped. Bulk density more than the amount defined herein as restricting root penetration.
- f. Heavy, sandy, gravelly or contaminated soil: Soil with more than 35% clay, 50% silt, 80% sand or 15% gravel, Unified Soil Classifications GW, GP, SW, SP, Pt, CH, MH. Organic content less than 2% or more than 8% by weight.
- g. Well drained subgrade soil: Soil intended to serve as the subgrade for addition of loam soil that infiltrates at a rate greater than 1 inch per hour as determined by an infiltrometer test.
- h. Subgrade soil: Soil intended to serve as the subgrade for the addition of loam soil or planting mix.

- i. Undisturbed soil horizon: A portion of the soil profile that has not been graded since the period when the land was in agricultural use or was forested; or, where previous human activity of grading was relatively minor and the soil structure, drainage and profile are still acceptable to support rooting of trees in the top 30 inches of the soil.

4. Bulk Density

Bulk density as a common measuring standard for horticultural soil. Bulk density is the soil's dry weight divided by its volume, most often expressed as grams per cubic centimeter ( $g/c^3$ ). Table 1 indicates bulk density of various soils. Root limiting levels change with soil type.

**Table 1. Bulk Density**

<u>Soil Class</u>	<u>Unified Soil</u>	<u>Bulk Density</u>
USDA Classification	Classification	$g/cm^3$ Beginning of root penetration restriction
Coarse sandy loam Loamy sand	GW, GP, SW, SP	1.60
Fine sandy loam Sandy clay loam Loam	SM, SC	1.50
Silty loam >30% sand	ML	1.45
Silty loam <30% sand	MH	1.40
Clay loam <35% clay	CL	1.40
Clay loam >35% clay	CH	1.35
Soils classified as Silt, clay, sandy clay Sand, silty clay	O, PT	Not usable as horticultural soil

5. Drainage Capability

- a. Drainage capability is to be the confirmed drainage infiltration rate in the subgrade and planting soil after all site construction is complete and just prior to the beginning of soil improvement work.
- b. Well drained soil or subgrade material: Soil that infiltrates at a rate greater than 1 inch per hour as determined by an infiltrometer test.

- c. Moderately drained soil or subgrade material: Soil that infiltrates at a rate less than 1 inch per hour but greater than ½ inch per hour as determined by an infiltrometer test.
- d. Poorly drained soil or subgrade material: Soil that infiltrates at a rate less than ½ inch per hour as determined by an infiltrometer test.
- e. Soil drainage assumptions: The following assumptions for post construction drainage capability may be made for planting soil and subsoil in the preparation of Soil and drainage modification plan and details. The following drainage capability assumes that the soil is not compacted to above root limiting density.

**Table 2. Drainage Capability by Soil Type**

USDA Classification	Unified Soil Classification	Drainage capability
Coarse sandy loam Loamy sand	GW, GP, GM, GC, SW, SP	Moderate to Well Drained
Fine sandy loam Sandy clay loam Loam	SM, SC	Moderate to Poorly Drained
Silty loam > 30% sand	ML	Moderate to Poorly Drained
Silty loam < 30% sand	MH	Poorly Drained
Clay loam < 35% clay	CL	Moderate to Poorly Drained
Clay loam > 35% clay	CH O, PT	Poorly Drained Moderate to Poorly Drained
Silt, clay, sandy clay Silty clay		Poorly Drained
Sand		Moderate to Well Drained

Moderate to Poorly Drained soils should be assumed to drain poorly until actual infiltration rate is confirmed after construction and just prior to the installation of drainage requirements.

- 6. Post construction soil conditions
  - a. At the time of permit application the landscape architect shall estimate the conditions of the soil compaction of planting and subgrade soil and drainage classifications at the end of construction, based on the soil and drainage type prior to construction, the type and intensity of construction, and amounts of grading proposed.
  - b. At the end of the construction period and within two weeks of the start of soil and drainage improvements, the landscape architect shall confirm the final soil conditions and drainage classifications. In any areas where the soil conditions do not match the estimated soil conditions, the landscape architect shall submit a revised soil and drainage plan.

- c. Soil conditions shall be classified as follows (see definitions):
    - Good
    - Graded
    - Compacted
    - Graded and compacted
    - Heavy, sandy, gravely or contaminated
    - Subgrade Soil
  - d. Soil drainage shall be tested and classified as follows (see definitions)
    - Well drained
    - Moderately drained
    - Poorly drained
7. Soil and drainage modification plan
- a. Submit a plan of the project that indicates the following:
    - 1. The extent of all areas to be planted including lawn, shrub and groundcover beds, trees and unplanted mulched beds. Soil plans shall include the symbols for trees but not individual shrub and ground cover designations in order to provide sufficient space to show the soil and drainage information.
    - 2. The post construction estimate of soil conditions and drainage classification for each area.
    - 3. The proposed soil improvements for each area.
    - 4. Soil improvements to any areas under pavements.
    - 5. The location of all drain lines, inspection risers, cleanouts, connection points to storm drains, drain line outfall locations and drywells. Drain lines shall indicate the invert elevation at all cleanouts, risers, connections to storm drains, outfalls and the top elevations of all drywells.
    - 6. Existing and proposed topographic contour lines at one-foot contour interval.
    - 7. Detail and section references.
    - 8. Required notes and certifications.
8. Soil and drainage details and sections
- a. Submit details and sections of all soil and drainage improvements. Details shall include the minimum soil and drainage details for each soil and drainage condition.
9. Soil and drainage specifications
- a. Submit standard soil and drainage improvement specifications to support the plans and details.

## **APPENDIX 'E': Landscape Plan Checklist**

<http://www.aacounty.org/IP/Resources/LandscapeChecklist.pdf>

# APPENDIX 'F': Plant List of Non-Recommended Plants

1. Aquatic Plants
  - Eurasian watermilfoil (*Myriophyllum spicatum*)
  - Giant salvinia (*Salvinia molesta*)
  - Hydrilla (*Hydrilla verticillata*)
  - Parrot feather watermilfoil (*Myriophyllum aquaticum*)
  - Water chestnut (*Trapa Natans*)
  
2. Herbaceous Plants
  - Garlic mustard (*Alliaria petiolata*)
  - Japanese knotweed (*Polygonum cuspidatum*)
  - Japanese stiltgrass (*Microstegium vimineum*)
  - Lesser celandine (*Ranunculus ficaria*)
  - Purple loosestrife (*Lythrum salicaria*)
  - Bamboos, exotic (*Bambusa, Phyllostachys and Pseudosassa*)
  - Canada thistle (*Cirsium arvense*)
  - Chinese lespedeza (*Lespedeza cuneata*)
  - Common daylily (*Hemeroallis fulva*)
  - Common reed (*Phragmites australis*)
  - Giant hogweed (*Heracleum mategazzianum*)
  - Giant reed, wild cane (*Arundo donax*)
  - Marsh dewflower (*Murdannia keisak*)
  - Spotted knapweed (*Centaurea biebersteinii*)
  
3. Shrubs
  - Autumn olive (*Elaeagnus umbellata*)
  - Bush honeysuckles, exotic (*Lonicera*)
  - Japanese barberry (*Berberis thunbergii*)
  - Multiflora rose (*Rosa multiflora*)
  - Privets (*Legustrum species*)
  - Wineberry (*Rubus phoenicolasius*)
  - Winged burning bush (*Euonymus alata*)
  - Butterfly bush (*buddleja*)
  - Japanese spiraea, Japanese meadowsweet (*Spiuraea japonica*)
  - Jetbead (*Rhodotypos scandens*)
  
4. Trees
  - Bradford pear (*Pyrus calleryana Bradford*)
  - Norway maple (*Acer platanoides*)
  - Princess tree (*Paulownia tomentosa*)
  - Tree of Heaven (*Aianthus altissima*)
  
  - Silk tree, mimosa tree (*Albizia julibrissin*)

Paper mulberry (*Broussonetia papyrifera*)  
Sawtooth oak (*Quercus acutissima*)  
White mulberry (*Morus alba*)

5. Vines

English ivy (*Hedera helix*)  
Kudzu (*Pueraria Montana v.lobata*)  
Mile-a-minute (*Polygonum perfoliatum*)  
Orienta bittersweet (*Celastrus orbiculatus*)  
Porcelainberry (*Ampelopsis brevipedunculata*)  
Wisterias, exotic (*Wisteria sinensis*, *W.floribunda*)  
Creeping euonymus (*Euonymus fortunei*)  
Five-leaved akebia (*Akebia quinata*)  
Japanese honeysuckle (*Lonicera japonica*)  
Louis' swallowwort (*Cynanchum louiseae*)  
Periwinkle (*Vinca minor*)



## APPENDIX 'G': Native Plant Species List

COMMON NAME	SCIENTIFIC NAME	TYPE
American Beech	<i>Fagus grandifolia</i>	T
American Elm	<i>Ulmus Americana</i>	T
American Sycamore	<i>Platanus occidentalis</i>	T
Green Ash	<i>Fraxinus pennsylvanica</i>	T
Aspen	<i>Populus grandidentata</i>	T
Bald Cypress	<i>Taxodium distichum</i>	T
Black Cherry	<i>Prunus serotina</i>	T
Black Gum	<i>Nyssa sylvatica</i>	T
Black Locust	<i>Robinia pseudoacacia</i>	T
Black Jack Oak	<i>Quercus marilandica</i>	T
Black Oak	<i>Quercus velutina</i>	T
Black Walnut	<i>Juglans nigra</i>	T
Black Willow	<i>Salix Nigra</i>	T
Chestnut Oak	<i>Quercus Prinus</i>	T
Common Persimmon	<i>Diospyros virginiana</i>	T
Eastern Cottonwood	<i>Populus deltoids</i>	T
Hackberry	<i>Celtis occidentalis</i>	T
Loblolly Pine	<i>Pinus taeda</i>	T
Mockernut Hickory	<i>Carya tomentosa</i>	T
Northern Red Oak	<i>Quercus borealis</i>	T
Pin Oak	<i>Quercus palustris</i>	T
Pignut Hickory	<i>Carya glabra</i>	T
Pitch Pine	<i>Pinus rigida</i>	T
Post Oak	<i>Quercus stellata</i>	T
Red Maple	<i>Acer rubrum</i>	T
Red Mulberry	<i>Morus rubra</i>	T
River Birch	<i>Betula nigra</i>	T
Sassafras	<i>Sassafras albidum</i>	T
Scarlet Oak	<i>Quercus coccinea</i>	T
Shortleaf Pine	<i>Pinus echinata</i>	T
Silver Maple	<i>Acer saccharinum</i>	T
Slippery Elm	<i>Ulmus rubra</i>	T
Smooth Alder	<i>Alnus serrulata</i>	T
Southern Red Oak	<i>Quercus falcate</i>	T
Swamp White Oak	<i>Quercus bicolor</i>	T
Sweet Gum	<i>Liquidambar styraciflua</i>	T
Virginia Pine	<i>Pinus virginiana</i>	T
White Ash	<i>Fraxinus Americana</i>	T
White Oak	<i>Quercus alba</i>	T
Willow Oak	<i>Quercus phellos</i>	T
Yellow Oak	<i>Quercus muehlenbergii</i>	T
Yellow Poplar	<i>Liriodendron tulipifera</i>	T

<b>COMMON Name</b>	<b>SCIENTIFIC NAME</b>	<b>TYPE</b>
American Holly	<i>Ilex opaca</i>	UT
American Hornbeam	<i>Carpinus caroliniana</i>	UT
Canby's hawthorn	<i>Crataegus canbyi</i>	UT
Chinquapin	<i>Castanea pumila</i>	UT
Choke Cherry	<i>Prunus virginiana</i>	UT
Dogwood	<i>Cornus florida</i>	UT
Eastern Redbud	<i>Cercis canadensis</i>	UT
Eastern Red Cedar	<i>Juniperus virginiana</i>	UT
Fringe Tree	<i>Chionanthus virginicus</i>	UT
Redbud	<i>Cercis canadensis</i>	UT
Southern Thorn	<i>Crataegus viridis</i>	UT
Smooth Alder	<i>Alnus serrulata</i>	UT
Wild Crab	<i>Pyrus coronaria</i>	UT
American Meadow-sweet	<i>Spiraea latifolia</i>	S
Bayberry	<i>Myrica pensylvanica</i>	S
Beach Plum	<i>Prunus maritima</i>	S
Black haw	<i>Viburnum prunifolium</i>	S
Blueberry	<i>Rubus cuneifolius</i>	S
Button bush	<i>Cephalanthus occidentalis</i>	S
Dangleberry	<i>Gaylussacia frondosa</i>	S
Deerberry	<i>Vaccinium stamineum</i>	S
Devil's Walking Stick	<i>Aralia spinosa</i>	S
Dwarf Azalea	<i>Rhododendron atlanticum</i>	S
Dwarf or Ginger Sumac	<i>Rhus copallina</i>	S
Dwarf huckleberry	<i>Gaylussacia dumosa</i>	S
Fetterbush	<i>Leucothoe racemosa</i>	S
Highbush Blueberry	<i>Vaccinium corymbosum</i>	S
High-tide bush	<i>Baccharis halimifolia</i>	S
Inkberry	<i>Ilex glabra</i>	S
Low Blueberry	<i>Vaccinium vacillans</i>	S
Male-Berry	<i>Lyonia ligustrina</i>	S
Maple-leaved Viburnum	<i>Viburnum acerifolium</i>	S
Mountain Laurel	<i>Kalmia latifolia</i>	S
Narrow-leaved Meadow Sweet	<i>Spiraea alba</i>	S
Obovate Serviceberry	<i>Amelanchier obovalis</i>	S
Paw Paw	<i>Asimina triloba</i>	S
Pink Azalea	<i>Rhododendron nudiflorum</i>	S
Possum Haw	<i>Ilex deciduas</i>	S
Red Chockberry	<i>Pyrus arbutifolia</i>	S
Silky Cornell	<i>Cornus amomum</i>	S
Smooth Arrowwood	<i>Viburnum recognitum</i>	S
Southern Arrowwood	<i>Viburnum dentatum</i>	S
Spicebush	<i>Lindera benzoin</i>	S
Staghorn Sumac	<i>Rhus typhina</i>	S
Staggerbush	<i>Lyonia mariana</i>	S
Strawberry Bush	<i>Euonymus americanus</i>	S
Swamp Azalea	<i>Rhododendron viscosum</i>	S
Pinxter Azalea	<i>Rhododendron canescens</i>	S
Sweet Fern	<i>Comptonia peregrina</i>	S
Sweetbay Magnolia	<i>Magnolia virginiana</i>	S
Sweet Pepperbush	<i>Clethra alnifolia</i>	S
Sweet Sumac	<i>Rhus glabra</i>	S

Tassel-white	<i>Itea virginica</i>	S
Wax Myrtle	<i>Myrica cerifera</i>	S
Winterberry	<i>Ilex laevigata</i>	S
Witch Hazel	<i>Hamamelis virginiana</i>	S
Ferns	(Fern Family)	G
Partridge Berry	<i>Mitchella repens</i>	G
Switch Grass	<i>Panicum virgatum</i>	G
Trumpet Creeper	<i>Campsis radicans</i>	G
Virginia Creeper	<i>Parthenocissus quinquefolia</i>	G
Wild Honeysuckle	<i>Lonicera dioica</i>	G
Big Cordgrass	<i>Spartina cynosuroides</i>	SG
Bluejoint	<i>Calamagrostis Canadensis</i>	SG
Cattail	<i>Typha</i> (spp.)	SG
Common Three-Square	( <i>Scirpus</i> (sp.))	SG
Panic Grass	<i>Dichanthelium</i> (spp.)	SG
Rushes	<i>Juncus</i> (spp.)	SG
Salt Meadow Hay	<i>Spartina patens</i>	SG
Salt Grass	<i>Distichlis spicata</i>	SG
Sedges	<i>Carex</i> (spp.)	SG
Smooth Cordgrass	<i>Spartina alterniflora</i>	SG
Wild Rice	<i>Zizania aquatica</i>	SG

## KEY

T	-	Trees
UT	-	Understory Trees
S	-	Shrubs
G	-	Ground Cover
SG	-	Shoreline Grasses

## APPENDIX 'H': Street Tree Plant List

### MAJOR TREES

Scientific Name	Common Name	Height	Width
<i>Acer rubrum</i> 'Armstrong'	Armstrong Red Maple	50'-60'	20'-25'
<i>Acer saccharum</i> 'Green Mountain'	Green Mountain Sugar Maple	50'-75'	40'-60'
<i>Betula nigra</i> 'Heritage'	Heritage River Birch (single stem)	40'-50'	40'-50'
<i>Carpinus betulus</i>	European Hornbeam	40'-60'	30'-40'
<i>Carpinus betulus</i> 'Fastigiata'	Fastigate European Hornbeam	35'-40'	20'-30'
<i>Celtis occidentalis</i> 'Prairie Pride'	"Prairie Pride" Hackberry	40'-50'	40'-50'
<i>Cladasris lutea</i> *	Yellowwood	30'-50'	40'-50'
<i>Fagus sylvatica</i>	European Beech	50'-75'	40'-60'
<i>Fraxinus pennsylvanica</i> 'Marshall'	'Marshall' Seedless Ash	45'-55'	35'-45'
<i>Ginko biloba</i>	Ginko (male grafted only)	50'-80'	40'-80'
<i>Gleditsia tricanthos</i> 'inermis'	Thornless Honeylocust	50'-70'	35'-50'
<i>Liquidambar styraciflua</i> 'Rotundiloba'	Sweetgum (fruitless)	65'-75'	40'-50'
<i>Nyssa sylvatica</i>	Blackgum	40'-70'	35'-45'
<i>Platanus x acerifolia</i> 'Bloodgood'	Bloodgood London Planetree	70'-80'	55'-65'
<i>Quercus bicolor</i>	Swamp White Oak	60'-80'	50'-80'
<i>Quercus rubra</i>	Northern Red Oak	60'-80'	45'-60'
<i>Quercus phellos</i>	Willow Oak	60'-75'	40'-60'
<i>Sophora japonica</i> 'Regent'*	Regent Scholartree	40'-70'	30'-40'
<i>Tilia cordata</i> 'Greenspire'	Greenspire Littleleaf Linden	50'-70'	35'-50'
<i>Tilia tomentosa</i>	Silver Linden	50'-60'	50'-60'
<i>Ulmus parvifolia</i>	Lacebark Elm	40'-45'	45'-50'
<i>Zelkova serrata</i> 'Village Green'	Village Green Zelkova	50'-60'	50'-60'

**MINOR TREES**

<i>Acer campestre</i>	Hedge Maple	30'-35'	30'-35'
<i>Acer ginnala</i>	Amur Maple	15'-20'	15'-25'
<i>Acer griseum</i>	Paperbark Maple	20'-30'	15'-25'
<i>Amelanchier laevis</i> *	Allegheny Serviceberry	30'-40'	15'-20'
<i>Carpinus caroliniana</i>	American Hornbeam	20'-40'	20'-30'
<i>Cercis canadensis</i> *	"Redbud Texas White"	20'-30'	15'-30'
<i>Cercis Canadensis</i> *	Eastern Redbud	20'-30'	15'-30'
<i>Chinoanthus virginicus</i> *	Fringetree (tree form)	12'-20'	12'-20'
<i>Cornus florida</i> *	White Flowering Dogwood	20'-30'	20'-30'
<i>Cornus florida</i> 'rubra'*	Pink Flowering Dogwood	20'-30'	20'-30'
<i>Cornus kousa</i> *	Kousa Dogwood	15'-20'	15'-20'
<i>Crataegus crusgalli</i> 'inermis'*	Thornless Cockspur Hawthorn	25'-30'	25'-35'
<i>Crataegus virdis</i> ' Winter King'*	Winter King Green Hawthorn	20'-35'	20'-35'
<i>Koeleruteria paniculata</i> *	Goldenraintree	30'-40'	30'-40'
<i>Malus x</i> 'Robinson'*	Robinson Flowering Crabapple	20'-25'	15'-20'
<i>Malus x</i> 'Callaway'*	Callaway Flowering Crabapple	15'-25'	15'-20'
<i>Prunus x incamp</i> 'Okame'*	Okame Cherry	15'-25'	15'-20'
<i>Prunus yedoensis</i> *	Yeoshino Cherry	35'-40'	35'-45'
<i>Pyrus calleryana</i> 'Aristocrat'*	Aristocrat Pear	35'-45'	25'-35'
<i>Pyrus calleryana</i> 'Redspire'	Redspire Pear	35'-45'	20'-25'
<i>Quercus myrsinifolia</i>	Chinese Evergreen Oak	30'-35'	30'-35'
<i>Stewartia pseudocamellia</i> *	Japanese Stewartia	30'-40'	20'-30'
<i>Stytax japonica</i> *	Japanese Snowbell	20'-30'	15'-25'
<i>Syringia reticulate</i> *	Japanese Treelilac	20'-25'	15'-20'
<i>Viburnum prunifolium</i>	Blackhaw Viburnum (tree form)	15'-20'	8'-12'

**\*Flowering Trees**

Plant major street trees at 40 foot on center. Trees shall be branched at a point approximately 60% of the total height of the tree above ground.  
 Plant minor street trees at 30 foot on center.

# APPENDIX 'I': Cost Estimates

## Cost Estimates

### Planting Costs (Installed)

a.	Major deciduous tree (2-2 ½ inch caliper):	\$400 ea.
b.	Minor deciduous tree (1 1/2-1 ¾ inch caliper):	\$200 ea.
c.	Evergreen tree (6 foot ht.)	\$250 ea.
d.	Shrub (24-36 inch)	\$ 50 ea.
e.	Herbaceous/Perennial plants (1gal.cont.)	\$ 9 ea.
f.	Ornamental Grasses (1 gal. Cont.)	\$ 9 ea.

### Site Work Costs (Installed)

a.	Mulched Berm (24 inch ht.)	\$ 15	per lineal ft.
b.	Wooden Fence (6 foot ht.)	\$ 15	per lineal ft.
c.	Vinyl Fence (6 foot ht.)	\$ 40	per lineal ft.
d.	Pre-Cast Stone wall (4 foot ht.)	\$ 40	per lineal ft.

# **PPENDIX 'J': Approved County Bill & Amendments**

## **VII. REFERENCES**

*Baltimore County Landscape Manual, Baltimore County Government, Adopted by Resolution 60-00 August 7, 2000 and as Amended.*