

CHAPTER I

GENERAL INSTRUCTIONS

**CHAPTER I
GENERAL INSTRUCTIONS
CHAPTER CONTENTS**

Page No.

I. GENERAL

A.	Introduction	I-1
	1. Purpose	I-1
	2. Authority	I-1
	3. Exceptions	I-1
B.	Definitions and Responsibilities	I-2
	1. Department of Public Works (DPW)	I-2
	2. Department of Planning and Code Enforcement (PACE).....	I-2
	3. Design Professional.....	I-2
	4. Developer	I-3
	5. Approval.....	I-3
	6. Capital Projects	I-3
	7. Development Projects	I-3
C.	Information Available From the County	I-4
D.	Revisions to this Design Manual, Standard Specifications and Standard Details.....	I-5
	1. Responsibility.....	I-5
	2. The Technical Review Committee (TRC)	I-5
	3. Procedure.....	I-5
E.	Use of Documents	I-8

II. CAPITAL PROJECTS

A.	General	I-8
B.	Pre-Design Meeting.....	I-8
C.	Reports	I-9
	1. Circumstances Requiring Reports	I-9
	2. Information Required	I-9
	3. Signatures/P.E.	I-11
	4. Format of Report	I-11
	5. Distribution of Reports.....	I-11
D.	Contract Drawings.....	I-11
	1. Drawings Required.....	I-12
	2. Information Required on Drawings	I-13
	3. Drafting and Graphic Standards	I-14
	4. Submission of Drawings to DPW	I-16
E.	Energy Conservation	I-16

	<u>Page No.</u>
F. Standard Materials and Equipment	I-16
1. Mechanical Systems	I-17
2. Electrical Systems	I-17
3. Architectural Systems.....	I-17
G. Warranties	I-17
H. Training Requirement	I-17
I. Specifications	I-18
1. Standard Specifications	I-18
2. Contract Special Provisions	I-18
J. Design Data and Computations.....	I-18
1. Conventional Methods	I-18
2. Computer Applications:	I-19
K. Quantities and Cost Estimates.....	I-19
1. Quantity Estimates	I-19
2. Cost Estimates	I-20
L. Miscellaneous Requirements.....	I-20
1. Location of Utilities	I-20
2. Discrepancies	I-20
3. Corrosion Control.....	I-20
4. Check Lists.....	I-21
5. Coordination with Outside Agencies	I-21

III. DEVELOPMENT PROJECTS

A. General	I-22
B. Contract Drawings and Documents.....	I-22
1. Reports	I-22
2. Contract Drawings.....	I-22
3. Specifications	I-23
4. Design Data and Computations.....	I-23
5. Quantity and Cost Estimates	I-23
6. Energy Conservation	I-23
7. Life-Cycle Costing	I-23
8. Record Drawings.....	I-23

IV. CONSTRUCTION

A. General	I-24
B. Contractor Health and Safety Plan	I-25

	<u>Page No.</u>
C. Protection of Existing Trees, Utilities, Buildings and Equipment	I-25
1. General	I-25
2. Tree Conservation	I-26
3. Utilities	I-26
4. Buildings	I-26
5. Equipment	I-27
D. Inspection	I-27
1. General	I-27
2. Geotechnical	I-27
E. Shop Drawings	I-29
F. Material Tests	I-29
G. Certification of the Design Intent	I-29
H. Record Drawings	I-30
1. General	I-30
2. Electronic Files	I-30
V. APPENDIX	I-30
A. Check List - All Contract Drawings	
B. Standard General Design Drawings	
C. Electronic Files Agreement	
D. Minimum Required Motor Efficiencies	
E. Development Project Processing Flow Chart	
F. Capital Project Processing Flow Chart	

ANNE ARUNDEL COUNTY DESIGN MANUAL**CHAPTER I****GENERAL INSTRUCTIONS****I. GENERAL****A. Introduction****1. Purpose**

The purpose of this Manual is to present procedures, standards, and criteria to be used by all design professionals in the preparation of designs requiring the approval of the Anne Arundel County Departments of Public Works and of Planning and Code Enforcement (PACE). This Manual, together with the County Code, Department of Public Works Standard Details and Specifications, BOCA and NFPA Codes, Anne Arundel County and National Standard Plumbing Codes, National Electric Code, Council of American Building Officials (CABO) Code, and the American Society of Heating Refrigeration and Air-Conditioning Engineers (ASHRAE) Standards, are used by these agencies in the review of all submissions requiring their approval.

2. Authority

The material presented in this Manual is in accordance with the authority and responsibility delegated by ordinance, resolution, and executive or administrative order to the various County agencies named herein.

3. Exceptions

If the design professional for any reason finds it necessary or desirable to use procedures, standards or criteria other than those included in this Manual, he/she must apply to the County for an exception. Three copies of any request for an exception are to be addressed to the Director of the Department of Public Works and shall, at a minimum, contain a narrative indicating the design objective and the justification for the request. The following information at a minimum will be addressed in the request: reason for the exception; statement of any hardships caused by adherence to the contents of the Design Manual; presentation of the proposed alternative(s) for exceptions to recommended procedure, equipment or materials; show comparisons of the service life, replacement cost, and maintenance costs of the alternative to the standard; performance history of proposed alternate procedure, equipment or material(s) and history of usage of proposed alternate methods, standards or criteria. The narrative and justification may be accompanied by drawings, photographs, catalog cuts or publications which the design professional deems necessary or desirable to support his/her position.

B. Definitions and Responsibilities

1. Department of Public Works (DPW)

- a. The Anne Arundel County Department of Public Works, its director, or his/her duly authorized representative.
- b. This Department, through its various bureaus, has the authority to review the design of County roads and entrances thereto, structures within County rights-of-way and easements, including bridges, culverts, storm drain systems, and the design of all County water and sewer facilities and any private systems connected thereto. Additionally, the DPW has the authority to inspect all infrastructure which is constructed under a Capital Project.

2. Department of Planning and Code Enforcement (PACE)

- a. The Anne Arundel County Department of Planning and Code Enforcement (PACE), its director, or his/her duly authorized representative.
- b. This Department has the authority to review the design of, issue permits for, and inspect all infrastructure, both public and private, and other improvements in Anne Arundel County, regardless of ownership, on all property within the County's jurisdiction, which are constructed in conjunction with Development Projects. PACE also has review authority over all stormwater management practices, regardless of ownership, on all property within the County's jurisdiction. It is responsible for the issuance of space permits and the enforcement of sediment control and soil conservation measures. For the design of such private property site improvements as on-site storm drains, exterior water and sanitary sewer facilities and paving, the criteria and standards in this Manual are recommended. PACE has the authority to review all proposed construction plans for compliance with subdivision and zoning rules in compliance with this Design Manual, and the Anne Arundel County Standard Details and Standard Specifications. Design professionals must consult the Anne Arundel County Zoning Ordinance and the Anne Arundel County Zoning Regulations to ensure that their plans conform to County zoning requirements. The design professional shall adhere to the requirements of the Anne Arundel County Subdivision Regulations for all subdivision design and development work.

3. Design Professional

- a. An individual, partnership, or corporation licensed under the laws of the State of Maryland to practice as an engineer, architect, landscape architect, land surveyor or property line surveyor.
- b. The design professional prepares contract drawings, land transfer documents, and other documents for construction projects in Anne Arundel County. It shall be the responsibility of the design professional to ensure that the various elements of

the project are prepared by appropriately licensed practitioners in the State of Maryland.

4. Developer

- a. An individual, partnership, or corporation (or agent thereof) that undertakes the preparation of a subdivision plat and/or a site development plan and the public and private improvements involved therein.

5. Approval

- a. Specific examination and acceptance by a duly authorized representative of the Anne Arundel County department or departments having appropriate review authority. Areas of review authority shall be as indicated above.

6. Capital Projects

- a. Capital projects are those projects which are initiated by the County through the Department of Public Works, or other County agency, and shall generally include the following items:

- 1) Reports
- 2) Rights-of-Way Plats
- 3) Contract Specifications
- 4) Contract Drawings
- 5) Design Data and Computations
- 6) Estimates of Quantities

- b. The review and approval for capital projects will be by the County department which contracted for the work supplemented by reviews of other County departments, State and Federal agencies having jurisdiction and issuing permits and/or indicating acceptance or approval of the documents related to the project as appropriate. See Appendix F for Capital Project Processing Flow Chart.

7. Development Projects

- a. General: Development projects are those projects, which are initiated by developers or their agents. Development projects may or may not involve the subdivision of land. All development projects are submitted to the Department of Planning and Code Enforcement for review and approval. PACE then refers the project to other appropriate agencies and departments, including DPW, Soil Conservation Service, and the State Highway Administration for review and/or approval in their particular areas of authority.

b. Public Portion:

- 1) The public portion is that portion of a development project, which falls within a public right-of-way or dedicated easement or is to be dedicated as a public right-of-way or easement in conjunction with the project.
- 2) The design of the public portion of a development project is required to be in strict accordance with the methods and criteria presented in this Manual. PACE will conduct a thorough review of the proposed plans to ensure compliance with this Design Manual and the Anne Arundel County Standard Details and Standard Specifications. See Appendix E for Development Project Processing Flow Chart.

c. Private Portion:

- 1) The private portion is that portion of a development project, which will remain the personal property of the developer or some subsequent purchaser. Examples of such improvements include storm drainage systems and parking lots for shopping centers or other commercial areas.
- 2) The design of the private portion of a development project is required to be in general accordance with this Manual, the Anne Arundel County Standard Details and Standard Specifications, the Anne Arundel County Code, and all applicable County regulations and ordinances. The use of this Manual as a guide in the design of the private portion of a development project will facilitate review by the Department of Planning and Code Enforcement.

C. Information Available From the County

The following types of information are on file and available from the various County departments and private utility companies:

1. Topographic maps, scale 1" = 200 ft.
2. Land use (zoning) maps, scale 1"= 200 ft.
3. Location or other engineering reports concerning the project and the area adjacent thereto.
4. Traffic data.
5. Legally established grades of existing streets.
6. Plans and right-of-way data of existing and proposed streets, alleys, storm drains, water mains, sanitary sewers, and mechanical/electrical conduits.
7. Plans of existing and proposed gas lines, telephone, cable, and other communications and electric lines, etc.
8. Survey data, including County benchmarks and survey control points.
9. Landscaping Manual

10. Stormwater Management Technical Manual
11. Reference Pumping Station Specifications
12. Reference Drawings for Wet Well/Dry Well and Submersible Pumping Stations
13. Reference Drawings for Liquid and Gas Storage Tanks
14. Reference Drawings for Concrete and Romar STEP and Gravity Septic Tank Installations
15. Reference Drawings for Grinder Pump Installations

That portion of the above information relevant to the project should be gathered and reviewed by the design professional. Anne Arundel County makes no guarantee as to the completeness, accuracy, or suitability of such information for use on any project. It is the responsibility of the design professional to verify all such information to his/her satisfaction and to arrange for all required field surveys, confirmation, test pits and/or identification.

On capital projects, all relevant record information will be furnished to the design professional at no cost to him/her. The information is also available to design professionals on development projects; however, a fee is charged for some of the data.

D. Revisions to this Design Manual, Standard Specifications and Standard Details

1. Responsibility

The Chief Engineer, DPW, is responsible for the processing review, and decision regarding approval of request for acceptance of new products, materials, concepts and alternate designs by Anne Arundel County. The Chief Engineer or his designee shall evaluate annually the need to update and/or revise the Design Manual, Standard Specifications and Standard Details. Additionally, the Chief Engineer, DPW, will be responsible for establishing and maintaining a Technical Review Committee to assist in performance of the above tasks.

2. The Technical Review Committee (TRC)

The Chief Engineer, DPW, will create a Technical Review Committee composed of personnel from the DPW, PACE, and other County agencies connected with design review, construction, maintenance and operations of County infrastructure and private sector representatives from the Anne Arundel County Engineer's Association, the Anne Arundel County Home Builder's Association, the Anne Arundel County Contractor's Association, the Maryland Contractor's Association, the Anne Arundel County Trade Council and others determined to be appropriate. Meetings of the Technical Review Committee (as a whole or with the individuals needed to resolve a particular issue) will be conducted as needed.

3. Procedure

- a. Requests for approval of new products, materials, concepts, and alternate designs.

- 1) Three (3) copies of a completed application for approval of new products, materials, concepts or alternate designs must be filed with the Chief Engineer, DPW. The request for approval should be prepared by a Professional Engineer permitted to practice in the State of Maryland. The request shall include the following information:
 - a) Reason for Request
 - b) Advantage or benefit of product, material, concept or alternate design over that currently used.
 - c) For products or materials: Manufacturer's specification, AASHTO or ASTM test data, approvals from other regulatory agencies, how long it has been in use and performance data.
 - d) Comparison of initial and ongoing maintenance cost use of product, material, concept or alternate design with that currently in use.
 - 2) Within one (1) week after insuring all information required to be submitted with the application has been provided, the Chief Engineer or his designee, will distribute the application to the appropriate members of the Technical Review Committee (TRC) who then have three (3) weeks to review the requests and submit their comments.
 - 3) Within approximately one (1) week after receipt of comments from the TRC member(s), the Chief Engineer will issue his recommendation for tentative approval or disapproval to the applicant.
 - 4) Interim approval for a request, associated with a specific project can be provided at the Chief Engineer's (DPW) discretion for use of the new product, material, concept or alternate design requested before formal revision of the respective documents as described in b., below.
- b. Periodic Revisions to the Design Manual, Standard Specifications and Standard Details.
- 1) Annually, the Chief Engineer, DPW, will determine whether amendments, revisions, deletions and additions to the Design Manual, Standard Specifications, and Standard Details need to be considered based on the following:
 - a) Written requests from an individual or group in either the public or private sectors addressed to the Chief Engineer DPW.
 - (1) The Chief Engineer will accept suggested changes to the Design Manual, the Standard Specifications and Standard Details at any time there is a perceived need.

- (2) The Chief Engineer or his designee will distribute the request within one (1) week of receipt to the appropriate members of the Technical Review Committee.
- (3) The Chief Engineer or his designee will conduct quarterly meetings, if needed, with appropriate members of the Technical Review Committee to review the merits of requested changes.
- (4) Approved changes will be incorporated annually into the Design Manual, Standard Specifications and/or Standard Details as appropriate.
 - b) Recent changes in the State and Federal regulations, design requirements and specifications.
 - c) New and/or improved products, materials, design procedures, concepts and design alternatives.
 - d) New products, materials, design concepts and alternative design procedures previously approved by Anne Arundel County as “interim” under section D.3. a. above.
- 2) The Chief Engineer or his designee will coordinate all reviews and comments on the proposed revisions and ensure the timetable established is followed and the process is advancing at the established schedule.
- 3) The Chief Engineer or his designee will finalize documentation of amendments, revisions, deletions and additions to the Design Manual, Standard Specifications, and Standard Details.
- 4) The amendments, revisions, deletions and additions will be incorporated into a revised draft of the Design Manual, Standard Specifications and/or Standard Details. The revised draft containing the amendments, revisions, deletions, and additions will be processed through the appropriate Technical Review Committee members for final comment.
- 5) Final decision to approve or reject the revisions to the Design Manual, Standard Specifications and/or Standard Details will then be made by the Chief Engineer.
- 6) The adopted revisions to the Design Manual, Standard Specifications and/or Standard Details will be distributed to all document holders of record by the DPW.

E. Use of Documents

Contract documents shall be re-evaluated by a responsible design professional and the County prior to bidding if the approved contract documents have not been bid within one year of the date the bid ready (signed and sealed) documents were delivered to the County.

All sketches, drawings, record drawings and other materials prepared by the design professional in connection with his/her work shall become the sole and absolute property of the County. The County reserves the right to use such documents for reference and public information. When delivering the documents to the County it is specifically understood that the documents which he/she has prepared are intended to be suitable for the original project application only and are NOT suitable for reuse by the County or others on extensions of his/her project or for use on any other project. Any reuse of the documents without written verification or adaptation by the design professional for a specific purpose other than intended will be at the user's sole risk and without liability or legal exposure to the original design professional.

II. CAPITAL PROJECTS

A. General

Capital projects are those projects, which are initiated by the County. Design standards and criteria for capital projects are normally those presented in this Manual, although additional criteria and/or standards may be provided, the current criteria and/or standards waived, or otherwise modified at the discretion of the County agency, which initiated the project. The design professional will enter into a contract with the County for the preparation of contract documents and/or other services appropriate for each specific capital project. The contract between Anne Arundel County and the design professional will specify specifically the documents to be submitted, together with their required content, for a particular project.

B. Pre-Design Meeting

Prior to commencing any design work, the design professional will meet with the DPW, and representatives of any other County, State, or Federal agencies affected by the project, to discuss specific design parameters. At this meeting the County will advise the design professional, in addition to this Design Manual, of any other County documents or conditions which may be applicable to the project design. The design professional shall present to the County to the extent possible at this meeting, his/her selection of alternates from the existing County design criteria and, to the extent possible at this meeting, approval of the alternates will be given by the County. If the design professional proposes to use products, materials, concepts or alternate designs different from those set forth in the County's design guidelines, the procedure for approval of the product,

procedure, etc., shall follow the procedure outlined for interim approval of new products, procedures, etc., as outlined in Section I.D. of this Chapter of the Design Manual.

Where selection of alternates is not possible at this meeting, a second meeting shall be held when sufficient decision making information is available.

C. Reports

1. Circumstances Requiring Reports

When specified in the agreement between the County and the design professional, the first stage of the project will be the preparation of an engineering design report.

2. Information Required

- a. General Description: A general description and history of the project under study is to be prepared. It shall include, but not be limited to, project purpose, site description, topography, location, existing conditions inventory, vegetation or site cover, etc.
- b. Existing Conditions: Existing conditions pertinent to the need and justification for the project may include but is not limited to: physical features; soil types and conditions; existing improvements; locations of utilities; and delineation of environmentally sensitive areas, if present.
- c. Geotechnical Information:
 - 1) A subsurface investigation will be performed in accordance with the following instructions of this Chapter, and the specific requirements of each subsequent Chapter.
 - 2) Geotechnical services provided during design will include the selection of boring and test pit locations, the selection of soil and/or rock sample types and intervals, the selection of appropriate field and laboratory test procedures, and the preparation of a geotechnical report interpreting the data and making recommendation concerning foundations. At a minimum, the report shall include the following:

Description of the investigation:

Materials encountered

- Types of measures that will be needed to check stabilization of excavations and provide values for design parameters (lateral earth pressure distribution, allowable slopes).
- Need for dewatering systems and description of groundwater conditions over project limits.

- Foundation preparation measures to be used.
- Allowable bearing pressures, anticipated total and differential settlement, pipe bedding requirements, etc., to support design loads.
- Backfill material characteristics required.
- Suitability of onsite excavated materials for use in fills and for pipe and structure backfill.
- Estimated volumes of borrow.
- The level of compaction needed to satisfy design criteria and methods of achieving this compaction through appropriate combinations of compaction equipment, water contents, and lift thicknesses.
- Pavement reconstruction considerations - address need for road reconstruction around excavations.
- The basis that will be used for field evaluation of material suitability, adequacy of compaction, acceptability of shoring, etc.
- Design considerations, including the potential sources and magnitudes of uncertainty in geotechnical conditions, and a guideline construction specification with respect to geotechnical requirements.
- Boring location plan.
- Boring logs

The report shall be signed and sealed by a professional engineer registered in the State of Maryland, and shall be included as part of the contract documents.

The contract drawings shall show the location of borings, test pits and any other subsurface testing or investigation.

- 3) Soil Analysis: Design professionals and the DPW shall analyze the results of the soil testing for corrosion considerations. If proposed pipes will be below or near the water table, the test borings shall be observed for a fluctuating water table. Soil samples shall be tested for pH, resistivity and chlorides. If organic soils are present, the samples shall be tested as above as well as for sulfides and sulfates. If sources of stray currents are present in the area of a proposed facility (i.e. welding shops, shipyards, gas stations, cathodically protected pipelines, or transit systems, or are parallel to electric power lines), or if stray currents are suspected of being present, the design professional shall recommend to the DPW that a study be performed by a NACE (National Association of Corrosion Engineers) certified corrosion engineer to confirm the presence of stray currents. If corrosion potentials are present, locate their sources and recommend a method to mitigate impacts.
- d. Proposed Work: Discussion of proposed work as to the location, size, operation, and other pertinent data.

- e. Options: Discussion of options and alternate methods with comparative costs of each scheme. Cost comparisons shall include construction costs and operational costs.
 - f. Life-Cycle Costing: If appropriate to the project, a detailed study of the life cycle costing of the various options under consideration for construction shall be prepared as part of the report. The economic analysis shall be based on total present worth, including maintenance costs.
 - g. Recommendations: Recommendations for implementation of the most appropriate design concept for the project including a discussion of the factors contributing to the selection of the design concept and a complete estimate of costs.
 - h. Drawings, Tables, etc.: Supporting drawings, tables, curves, and any other data necessary to support and clarify the written conclusions.
3. Signatures/P.E.

Reports shall be signed by a principal member of the firm or by a licensed design professional employed by the firm under whose direction they have been prepared.

4. Format of Report

All reports shall be machine printed, copied, or printed on 8-1/2" x 11" paper and bound in a suitable cover, properly titled, and indexed.

5. Distribution of Reports

The number of copies of reports called for in the design professional's contract with the County shall be submitted to the County by the scheduled date.

D. Contract Drawings

Public improvements proposed in major subdivisions may require contract drawings conforming to the standard format for public drawings specified in this manual. The drawings will depict the construction criteria and details necessary for the satisfactory installation of all publicly owned facilities for the following:

- Roads
- Bridges
- Water systems
- Sanitary sewer systems
- Storm drainage systems
- Stormwater management facilities

- Traffic control for construction
- Sediment and erosion control devices
- Cross sections
- Any combination of the above.

The processing of contract drawings is outlined in a policy by the DPW, and the DPW should be consulted before preparing contract drawings. See Appendix A for a contract drawing checklist.

1. Drawings Required

- a. Title Sheet: If a set of construction drawings exceeds four (4) sheets, a separate title sheet shall be included as the first sheet.
- b. Summary Sheets: When specified in the design professional's contract with the County, the final sheet of the contract drawings shall be a quantity summary sheet.
- c. Sediment Control Sheets: All construction drawings which require sediment control, as specified in the Anne Arundel County "Grading and Sediment Control Ordinance" shall have plan and detail sheets dedicated exclusively to sediment control. These sheets shall show all sediment control measures as well as all other information required by the "Anne Arundel County Sediment Control Ordinance", 1994, or the latest "Maryland Standards and Specifications for Soil Erosion and Sediment Control" and the Anne Arundel Soil Conservation District. Additional information is required when working in the Chesapeake Bay Critical Area or a County designated sensitive area. Sediment control drawings shall conform to the size and format specified below. All sediment and erosion control drawings and specifications are reviewed and approved by the district office of the Soil Conservation Service.
- d. Drawing Sheets: The purpose of the contract drawings is to portray graphically to the review agencies, project engineer and contractor the nature and extent of the proposed work and the conditions under which the work is to be performed. All information, which can best be shown by drawings and their accompanying dimensions and notes, should be shown on the contract drawings or appropriate reference to the County's Standard Details made where applicable. Lengthy written descriptions or requirements regarding the work are best included in the specifications and therefore should not be repeated on the drawings.

Drawings for street improvements, structures, and each type of utility shall be presented on separate sheets when more than one of these types of work is included in the same construction contract except as permitted for Minor Subdivision Projects where combining would provide clarity. The exact content

and format of the drawings for each type of work shall be as specified in the appropriate Chapter(s) of this Manual.

- e. Cross Sections: On certain projects cross sections may be required by the initiating agency. When required, cross-sections shall be drawn to a scale of 1" = 4' or 1" = 5' horizontally, and 1" = 4' or 1" = 5' vertically. The number and spacing of cross sections shall be as required for construction and quantity takeoff and as required by the agency.

2. Information Required on Drawings

- a. Title Block: Each sheet shall have a title block in the lower right-hand corner. The title block shall show the project name, sheet title, contract numbers, scale, date, sheet number, and signature blocks for DPW. Sheets shall be numbered sequentially 1 through x, where x is the total number of sheets in the contract. Each discipline shall also number each drawing in its group sequentially and prefix the drawing number with a letter abbreviation representing the discipline, e.g. C1 through CX for Civil, in the drawing description block. See Standard Reference Drawings G-4.1, 4.2, and 4.3 in Appendix B for specific format.
- b. Approval and Certificate Blocks: Sediment and erosion control sheets shall contain developer's and engineer's certifications. Contact the Anne Arundel Soil Conservation District for current certification blocks.
- c. Vicinity Map: The title sheet, when required, and the first sheet of each division of work shall have a vicinity map. See Standard Reference Drawing G-7 in Appendix B. The vicinity map shall be drawn at a scale of 1" = 2000' and shall show predominant, well-known streets. The proposed work site shall be clearly indicated.
- d. Location Map: The title sheet, when required, and the first sheet of each division of work shall have a location map. See Standard Reference Drawing G-7 in Appendix
- e. Seal and Signature: Professional seal, signature, date on which seal and signature were affixed to the drawing, and registration number of the design professional responsible for the design shall be shown on the title block of each sheet.
- f. Dates: The date on which the drawing is completed shall be shown.
- g. Revision Box: Each sheet shall have a revision box in the title block. The revision box shall be as shown on Standard Reference Drawings G-4.1, 4.2, and 4.3 in the Appendix. Revision block shall document all revisions after the design professional's seal and signature has been affixed to the drawing.
- h. Bench Marks: Anne Arundel County benchmarks used for design and temporary benchmarks shall be shown on the location plan and, where practical, on the

individual contract drawings. A complete description of each benchmark stating designation, location, elevation, and datum reference shall be shown near the location plan. Recovery cards for existing Anne Arundel County benchmarks are available at the DPW.

- i. Coordinates: Each plan sheet shall show a minimum of three coordinated grid ticks based on the Anne Arundel County grid system and all bearings shall be related to grid north. The grid system shall be identified on each plan sheet as NAD 83 or NAD 83/91, except NAD 27 grid systems may remain on sheets for ongoing projects, only. Two of these grid ticks shall be on the same N-S or E-W line. The coordinated grid ticks shall be at multiples of 250'. Recovery cards for Anne Arundel County horizontal control stations are available at the DPW. Coordinated P.I.'s, etc. will be required as specified in each Chapter of this Manual.

In order to facilitate the inventory of County facilities into the GIS database, all principal facilities in a project shall be indicated on the contract drawings with coordinate values (i.e. centerline of street intersections, PC's and PT's of curves, backwalls of bridges, traffic signal poles, inlets, manholes, fire hydrants, valves, bends, tees, etc.).

- j. Contract Limits: Limits of contract shall be clearly shown on all drawings.
 - k. North Arrow: Each plan sheet and location map shall have a north arrow. Plan sheets shall be so oriented that the north arrow points toward the top or toward the right side of the sheet or toward the upper right quadrant of the sheet.
 - l. General Notes: Notes common to all contract drawings shall be shown on the first sheet of the set and labeled "General Notes."
 - m. Design Criteria or Basis: Basic design criteria and basis of design shall be included on the drawings as specified in the appropriate Chapter(s) of this Manual.
3. Drafting and Graphic Standards
 - a. Drafting Media: Drawings shall be prepared on polyester drafting film (mylar, minimum thickness 0.004 inches). All drafting and lettering shall be performed directly on the original drawing and no reproductions, rub-on or adhesive materials shall be used. All recorded and existing features shall be drawn and labeled in ink. All proposed features should be drawn and labeled in pencil or ink.

If a reproducible is to be submitted and used as a base sheet for construction plans, it shall be a photographic process, e.g. by camera, engineering quality photo copier, scanner/printer, on polyester drafting film (mylar) with a minimum

thickness of 0.004 inches. Line work and lettering shall be durable and well bonded to the drafting film so that they do not scrape off. No mylar sepias are permitted.

- b. Sheet Size and Borders: All drawings shall be of the size shown in Standard Reference Drawing G-3 in the Appendix. Borders shall be as indicated in the Appendix.
- c. Scale: All plans shall be drawn to a scale of 1" = 40' and all profiles to a horizontal scale of 1" = 40' and a vertical scale of 1" = 4' unless directed otherwise in a specific Chapter of this Manual. Traffic signal plans shall be drawn to a scale of 1" = 20'. The scale to be used for details on any one set of drawings shall be 1/4", 1/2", 1", 3/8", 3/4", or 1-1/2" = 1'-0".
- d. Use of Standard Symbols and Abbreviations: The standard symbols and abbreviations shown in Standard Reference Drawings G-1.1 and G-1.2 in the Appendix shall be used wherever possible. Nonstandard symbols and abbreviations deemed necessary should be clearly defined in a legend on the title sheet or the first sheet of the category in which they are used. If symbols fail to convey the required information clearly, they shall not be used.
- e. Match Lines and Cross-References: All drawings in the same contract shall be cross-referenced by accession numbers. Match lines with a minimum length of 4" shall be identified by accession number of the matching sheet and shall be used wherever the drawing is to be continued on the same or another sheet. Data shall be cut off at the match line; duplication of data on matching sheets is not to be permitted.
- f. Dimensioning and Elevations: Building dimensions less than one foot shall be indicated as inches. Building dimensions greater than one foot shall be indicated as feet and inches. All floor elevations, invert elevations, and finish grade elevations shall be shown to hundredths of a foot. General earthwork grades shall be shown to tenths of a foot. Duplicate dimensions shall be eliminated as much as possible.
- g. Size and Style of Lettering: Refer to Standard Reference Drawing G-2 in the Appendix.

All notes, descriptions, etc. shall be minimum of No. 5 (5/32") in size and shall be either all upper case or all lower case. Proper names only shall be capitalized. Construction notes shall not be placed in shaded areas. Crowding of notes into a small space shall be avoided. Where deemed necessary No. 3 (3/32") lettering may be used. Leaders shall be used to clarify the object to which each note refers.

Where two or more drafters work on a drawing or drawings, individual styles shall be subordinated to represent work in a general uniform style. All lettering in the same contract shall be of the same style.

- h. Computer-Aided Drafting (CAD): Computer-aided drafting may be used on any project if the design professional so desires. All requirements of this section, "Drafting and Graphic Standards", must be met with the exception of pen and pencil requirements. Plotters used for CAD must be equipped with technical ballpoint pens or standard drafting pens or any electronic printer device. Electronic deliverables to the County (i.e. CAD disks, CD's, etc.) must be in software formatting compatible with existing County systems. The format to be used will be decided at the pre-design meeting. The electronic file agreement shown in Appendix C shall accompany all electronic deliverables submitted to the County.
- i. Numbering of Utilities: All utility structures shall be sequentially numbered as specified in each Chapter.

4. Submission of Drawings to DPW

- a. Number of Prints Required: The number of prints of contract drawings to be submitted to the DPW for each contract phase shall be as specified in the agreement between the design professional and Anne Arundel County.
- b. Assignment of Drawing Numbers: Anne Arundel County drawing numbers and job order numbers shall be assigned by DPW.

E. Energy Conservation

The design professional shall, in all aspects of his/her design, specify materials and equipment, which are energy efficient. The County currently mandates compliance with the BOCA National Energy Conservation Code - 1993.

Compliance with BOCA/93 represents the minimum acceptable level of energy conservation. The design professional shall consider additional technologies that can reduce the life-cycle cost of the project. The design professional shall specify the use of T-8 lamps with electronic ballasts, compact florescent lamps, or high intensity discharge lamps for project lighting. All three-phase electric motors 1 horsepower or greater shall be specified to be premium efficiency. See Appendix D for minimum required motor efficiencies.

F. Standard Materials and Equipment

In order to facilitate maintenance of facilities, frequently replaced equipment should be standardized to include one or two manufacturers to minimize replacement part inventories and allow rapid efficient replacement. A current list of standard equipment, parts and materials applicable to the project will be provided to the design professional at

the pre-design meeting. Items which could be included on the list of standard equipment, parts and materials are:

1. Mechanical Systems
 - HVAC equipment
 - Plumbing materials and fixtures
 - Water and wastewater pumps
2. Electrical Systems
 - Controls
 - Lighting
 - Computer equipment
 - Programmable logic controllers
 - Remote terminal units
 - Radio equipment
 - Telemetry units
 - Traffic signal equipment
 - Alarms
3. Architectural Systems
 - Doors
 - Windows
 - Hardware
 - Locks and keys

G. Warranties

The project specifications shall include a detailed list of all manufacturers' warranties applicable to the project which will be delivered to the County by the contractor. Long-term warranties (those which will extend beyond the typical contractor's one-year guarantee) shall clearly state that the warranty is transferred to the County following the contractor's guarantee period.

Items typically covered by long-term warranties include pre-engineered buildings, roofs, fences, finishes, flooring, windows, doors, HVAC equipment, etc.

H. Training Requirement

The design professional shall incorporate into the specifications the services of a manufacturer's representative to conduct group training of the County's designated

personnel in the operation of each appropriate system, including instruction covering basic system theory, operating principals, and adjustments, routine maintenance and repair and “hands-on” operation. The manufacturer’s representative must be a factory trained employee of the manufacturer. Sales representatives will not be considered acceptable. The number and duration of the group training sessions, as well as specific systems for which training is required, shall be jointly determined by the design professional and County operations personnel.

I. Specifications

1. Standard Specifications

The specifications for all Anne Arundel County engineering projects shall be the latest edition of the "Anne Arundel County Standard Specifications and Details Manual" and all revisions and addenda thereto.

2. Contract Special Provisions

Where conditions of the project require deviation from the Standard Specifications, the contract documents shall include special provisions. Special provisions shall consist of modifications or additions to the Standard Specifications to completely describe and specify all nonstandard items of work on the contract drawings; however, the special provisions shall not repeat the Standard Specifications. The special provisions shall be prepared by the design professional. The number of copies of contract special provisions to be submitted to the DPW for each review submission shall be the same as the number of prints of contract drawings required.

Specifications prepared for the DPW will not use restrictive language or requirements. All construction contracts will be in accordance with the County Code’s emphasis on competitive bidding requiring the following:

- a. That the words “or equal” must follow any list of acceptable manufacturers described for a specified product unless manufacturers have been pre-qualified;
- b. If the words “or equal” do not appear, they must be considered as appearing unless specifically indicated otherwise; and
- c. If a manufacturer submits its product and demonstrates it is an equal, and the DPW does not have a substantive reason for denying the “or equal” claim, the substituted manufacturer’s product must be accepted.

J. Design Data and Computations

1. Conventional Methods

The design professional shall furnish design data and computations as specified in subsequent Chapters unless written consent for omission is obtained from the

County. The design data and computations shall be on 8-1/2" x 11" sheets, bound in a folder satisfactory for filing, and labeled for identification by title, location, and job order number. This data shall be submitted to the County along with the final contract drawings and specifications.

2. Computer Applications:

- a. Program Approval: Computer programs in the public domain and proprietary computer programs may be used by the design professional with the approval of the appropriate County department. Submittal of the programs to be used shall be made at the pre-design meeting. The currently approved computer programs can be identified by contacting the Chief of Drafting, Records and Research, Bureau of Engineering, DPW. A limited number of programs are mandatory for specific applications and can be identified by contacting the County. To secure approval for the use of additional computer programs, program documentation, especially computational methodology, must be submitted to the County for review prior to the use of the program in design. A standard benchmark run of the program, including program input and output and the corresponding longhand calculations must also be submitted. At the County's option, the County may supply standard data to be run in the program.
- b. Submission Requirements: Computer-aided design computations must be submitted in the same format as detailed above, except computer print-outs may be bound, unburst, in a nylon-post binder.

K. Quantities and Cost Estimates

1. Quantity Estimates

The design professional shall furnish a tabulated estimate of quantities including contingent items which shall be submitted to the County as part of the contract specifications.

The quantities and costs shall be arranged and divided into the standard Construction Specifications Institute (CSI) format. Division Two, Site Work, shall be further divided as follows:

- Grading, Excavation, Demolition, and Sediment and Erosion Control
- Storm Drainage
- Structures
- Paving
- Shoulders
- Landscaping
- Site Utilities (Water, Sewer, Mechanical/Electrical)

2. Cost Estimates

The design professional shall furnish a cost estimate to the County. This estimate shall be based on the quantity estimate described above. A unit price developed by the design professional or based on historical cost data furnished by the County shall be applied to each item of work to develop the cost estimate. Should the actual low contract bid differ from the design professional's estimate by more than the amount specified in the design professional's contract, he/she may be required to re-analyze his/her estimate, together with the low bid, to account for the variance. A written report detailing and explaining the discrepancies may be required by the County, as specified in the design professional's contract.

L. Miscellaneous Requirements

1. Location of Utilities

- a. Existing Utilities: The design professional shall be responsible for obtaining record locations from the utility companies and the County for determination of clearances and/or relocation requirements of gas, telephone, cables (including television, electric, and County-owned signal detector cables and conduits), water, storm drains, sanitary sewers, etc., or to conduct test pit operations to obtain critical design data as directed by the County.
- b. Proposed Utilities: In developed areas with existing utilities, the design professional shall locate new or replacement utilities within the public right-of-way as closely as practicable to the general location arrangements shown on Standard Reference Drawing Nos. G-8 and G-9 in Appendix B. In new developments, the design professional shall locate new utilities as shown on Standard Reference Drawing Nos. G-8 and G-9.

2. Discrepancies

Any discrepancies between these and other County Standards and regulations shall be referred to the County for interpretation.

3. Corrosion Control

- a. Underground facilities: The design professional shall design corrosion protection for underground facilities using coatings and/or cathodic protection measures and/or soil remediation measures as may be required in accordance with the standards and practices applicable to the materials selected. Underground facilities shall include, but not necessarily be limited to: all pipelines and their appurtenances; buried cables; buried storage tanks; bottoms of aboveground storage tanks; pilings and footers for walls, piers, abutments, buildings, etc.; wells; and retaining walls.

- b. Aboveground Facilities: The design professional shall design corrosion protection for facilities exposed to the atmosphere and salt spray using coatings designed for the specific purpose and meeting all federal and state volatile organic compounds (VOC's) restrictions. Coatings shall be selected for durability, life cycle cost, ease of application, finish, color and any special environmental conditions, which may exist. Selection of color shall be determined by aesthetics, the need to designate a facility's use (i.e. color-coded process piping or doors opening into hazard areas), the need to improve visibility (i.e. fire hydrants, close clearance structures, or tall structures near airports), or for environmental considerations (i.e. heat or light reflective or non-reflective surfaces). Aboveground structures include, but are not necessarily limited to aboveground storage tanks; bridge superstructures; exposed piping; fences; buildings and building components such as doors, windows, gutters and downspouts, and trim; fire hydrants; equipment; and signs and sign supports.
 - c. Immersed Facilities: The design professional shall design corrosion protection for immersed facilities using coatings and/or cathodic protection systems. Coatings shall be selected primarily for their durability and life cycle cost in the immersion medium and, in the case of potable water systems, for their low toxicity and lack of taste imparted to the water. Cathodic protection systems shall be designed to function fully in fluctuating water levels (i.e. tidal zones and storage tank interiors) and to function in addition to the coating to protect the structure. Immersed facilities include, but are not necessarily limited to storage tank interiors, inside surfaces of water and sewer pipelines and process piping, submersible equipment, submerged structural supports, submerged pipeline exteriors, manholes, and water and wastewater treatment plant tanks and basins.
 - d. Coating Systems: It shall be the responsibility of the design professional to specify surface preparations which meet the requirements of the selected coating system and to select a coating system, consisting of primer, intermediate and finish coats, all components of which are compatible with each other. Whenever possible, coatings should be specified to be a system from a single manufacturer.
4. Check Lists

The design of each utility shall be verified by checklists contained in subsequent Chapters. The design professional shall verify that all information detailed on the check list is shown on the drawings and shall submit one copy of the completed checklist along with the final drawings.

5. Coordination with Outside Agencies

It is the responsibility of the design professional to contact all other agencies and companies having facilities and/or review/permitting responsibilities, which will be affected by the proposed work to determine all relocation and coordination requirements. Such agencies and companies include, but are not limited to:

Baltimore Gas & Electric Company, Bell Atlantic Telephone Company, American Telephone & Telegraph Company, fiber optics companies, cable TV companies, State Highway Administration, Mass Transit Administration, Maryland Aviation Administration, environmental agencies, etc.

III. DEVELOPMENT PROJECTS

A. General

Development projects are those initiated by private parties as outlined in Section I.B. of this Chapter. Development regulations are administered by the Department of Planning and Code Enforcement which must be consulted during the development process.

It is the responsibility of the developer to engage a design professional of his/her own choosing and to pay all of the design professional's fees. In the case of a development project, the developer is the design professional's client, and the design professional should be guided by the developer, assuring that the County requirements listed above are met.

B. Contract Drawings and Documents

1. Reports

When directed by the County, the developer's design professional shall be required to submit engineering design reports. Typically, as directed by the Department of Planning and Code Enforcement, reports may be required for large development projects and will address such areas as increased traffic on County and/or State roads due to the impact of extensive development, expansion of existing water or sanitary sewer facilities, water quality and quantity management, reforestation, impact to environmentally sensitive areas, etc. The number of copies of reports to be produced, and their distribution, shall be as directed by the County. All other aspects of engineering reports such as content and format shall be as detailed in Section II.C. of this Chapter.

2. Contract Drawings

In minor subdivisions, whenever work is contemplated within public rights-of-way, contract drawings may be required in connection with the Public Works Agreement. The requirements for contract drawings will be determined by PACE. Exceptions to this requirement are "Descriptive" projects. "Descriptive" projects are those projects which are too small to require drawings (i.e., pavement repairs, sidewalk construction, etc.) and can be executed with a project description, which refers to the County's Standard Specifications and Standard Details.

Contract drawings for public portions of development projects shall be in accordance with this Chapter. Contract drawings for private portions of development projects

may omit the title sheet and may be in a format and to a scale compatible with architectural drawings for the project, but must have all signature blocks, etc. and convey all of the information detailed in this Chapter. The number of sets of contract drawings to be submitted to the County, and their distribution, shall be as noted on the various permit applications.

3. Specifications

Specifications for private and public portions of development projects shall be in accordance with Section I.B.7. of this Chapter and shall be sufficient to ensure that construction proceeds in accordance with the design professional's intent.

4. Design Data and Computations

Design data and computations shall be in accordance with the requirements of the appropriate Chapter(s) of this Manual.

5. Quantity and Cost Estimates

Quantity and cost estimates for public portions of development projects shall be as detailed in this Chapter. Quantity and cost estimates may be required for private portions of development projects as directed by the Department of Planning and Code Enforcement. In cases when cost estimates are required, unit prices furnished by DPW shall be utilized to the extent possible.

6. Energy Conservation

The public portion of development projects shall adhere to the requirements for energy conservation as presented in Section II.E. of this Chapter.

7. Life-Cycle Costing

If appropriate to the project, a detailed study of the life-cycle costing of the various options under consideration for construction shall be prepared as part of the design documents submitted for County approval unless specifically waived. The economic analysis shall be based on total present worth, including maintenance costs.

8. Record Drawings

- a. General: Upon completion of a development project, the developer shall submit two sets of record drawings to the County. These drawings shall be one set of reproducible and one set of prints of the approved construction plans with the "as-built" location of all deviating surveyable features indicated in red. The record drawings shall be based on a field-run survey prepared, sealed, and signed by the appropriate design professional.

Record drawings shall be as described in Section IV, Construction, of this Chapter.

- b. Electronic Files: For projects, which utilize CAD drawings, the County shall be furnished with record drawings on electronic files. The electronic files shall be as described in Section IV, Construction of this Chapter.

IV. CONSTRUCTION

A. General

The construction phase will commence with the award of the construction contract and will terminate when the contractor receives notification of final acceptance.

During the construction phase, the inspector responsible for inspection of capital projects and the public portion of development projects shall provide various reviews and occasional site visits and other services to aid the County in the administration of the construction contracts. On capital projects the inspector is usually a design professional whose services shall be as outlined in this Section and more specifically outlined in the design professional's inspection contract with the County. On development projects the County is represented in most cases by a PACE inspector, and construction shall be performed in accordance with the approved development plans, the County's Standard Specifications and Details and the Public Works and/or Utility Agreement. If the work is performed by County personnel, there is no contract and the services outlined in this Section will not apply.

The design professional shall make provisions in the project specifications for the following materials to be submitted to the County following completion of construction:

- Contract addenda
- Responses to Requests for Information (RFI's)
- Record drawings showing all changed conditions and changes to the design.
- Change directives
- Field modifications (those changes without formal change directives)
- Record set of shop drawings/certifications
- Inspector's daily log
- Material delivery tickets
- Construction photographs
- Electronic files in AutoCAD Version 14.0 for all contract drawings.

B. Contractor Health and Safety Plan

The design professional shall provide in the project specifications for capital projects that the contractor submits to the County a project Health and Safety Plan. It is expressly understood that the submittal of the contractor's Health and Safety Plan is for the County's information purposes only and any comments shall not be construed as to represent approval by the County or to relieve in any way the contractor's sole responsibility for the protection of human health and the environment as a result of any of its or its subcontractor's work at the site.

The specification shall state that the contractor is solely responsible for the safety, health and welfare of its and its subcontractor's personnel and equipment and for the protection of human health and the environment from potential threats arising out of its performance of all work on the site. The health and safety plan shall be submitted to the County prior to the mobilization of any equipment or personnel at the project site.

The Health and Safety Plan shall summarize how the contractor will monitor its work efforts and the precautionary/remedial measures that will be implemented to provide for safety and protection of human health and the environment. The Health and Safety Plan shall be in conformance with guidelines established by the U.S. Environmental Protection Agency (EPA), U.S. Occupational Safety and Health Administration (OSHA), Maryland Occupational Safety and Health Act (MOSH), the Maryland Department of Health and Mental Hygiene and Department of Environment and all other Federal and State Agencies having jurisdiction.

The Health and Safety Plan should include a statement listing any known existing site conditions which constitute a health or safety hazard such as the presence of gas at or near landfills, toxic soil conditions, biohazards, overhead electric lines, high pressure gas mains, etc. The Plan should also include a statement listing any equipment or procedures which the contractor will employ in the execution of the contract which may require special safety measures such as the use of explosives and blasting, equipment containing radioactive materials, equipment emitting high intensity light beams or sounds, use of hazardous chemicals, etc.

C. Protection of Existing Trees, Utilities, Buildings and Equipment

For any capital or development project the design professional shall as part of the design process develop drawings and specifications which direct the contractor to protect existing trees, utilities, structures and equipment adjacent to or within the limits of work, from damage caused by the contractor's operations.

1. General

- a. The design should provide for the continuous operation of all buildings, utilities and equipment without interruption.

- b. The contractor should be directed to control all dust, fumes and noise resulting from its work.
 - c. The design professional and the contractor should refrain from specifying or employing any construction methods involving use of explosives unless special circumstances make their use imperative.
2. Tree Conservation
- a. The design professional should consider the use of water, fertilizer and mulch to reduce stress to trees to be protected.
 - b. The contractor should be directed to retain the services of an International Society of Arboriculture (I.S.A.) certified arborist with a minimum of 2 years experience in tree preservation to supervise implementation of procedures for tree protection, to monitor tree health during construction and to supervise any repair of tree damages after construction.
 - c. The design professional shall be governed by the provisions of the Maryland Forest Conservation Act of 1991, and any amendments thereto, and the Anne Arundel County Standard Specifications, Section 02120, when specifying tree protection measures
3. Utilities
- a. The design professional shall specify methods of support and protection for existing buried utilities, which will be exposed by the contractor's work.
 - b. Where existing buried utilities will not be exposed by the contractor's work but may be subjected to construction loads from heavy equipment or stored materials, the design professional shall specify methods for their protection.
 - c. The design professional shall direct the contractor to avoid or protect aerial utilities in accordance with the National Electric Code, or to temporarily or permanently relocate the utilities in accordance with the standards and procedures of each respective effected utility.
4. Buildings
- a. The design professional should direct the contractor to record the condition of each building and its contents, which might be subject to damage as the result of any proposed work. Recordation should be performed by a professional engineer registered in the State of Maryland acting as the building inspector accompanied by a photographer who will make color photographs of the interior and exterior of each building and its contents. The photographs may be supplemented by electronic media such as videotapes, voice recording tapes, x-rays, etc. The

building owner should sign an affidavit acknowledging concurrence with the inspection.

- b. If any building should be considered to be at particular risk of damage, the design professional shall specify the use of methods and/or equipment considered to be the best practice for mitigating the damage risk.

5. Equipment

- a. Where sensitive equipment such as motors, computers, electronic scales, etc., processes such as food production or preparation, chemical or biological work, water treatment, etc. may be exposed to dust, vibration, temperature fluctuations, etc., due to the proposed work, the design professional shall specify the use of methods and/or equipment which will minimize risk of damage or contamination.
- b. Work methods should be considered which minimize or eliminate the risk of materials or equipment being dropped onto operating equipment. Suitable shielding or change in direction of lifts should be considered.
- c. The design professional should make the contractor aware of any potentially hazardous environments, which may require the use of special equipment to avoid explosions or fires or the generation of hazardous fumes. The presence or potential presence of lead paint or asbestos must be brought to the contractor's attention.

D. Inspection

1. General

Unless the design professional's contract with Anne Arundel County specifically requires that he/she provide inspection services, all inspection of construction projects is carried out by Anne Arundel County or its authorized agent.

In cases where the design professional is not providing construction inspection, he/she will still be required to attend construction progress meetings and visit the site periodically to determine, in general, if the work is proceeding in accordance with the contract design intent.

Any significant changes to construction drawings, or requests for same, together with the conditions necessitating the changes, shall be submitted to the design professional for his/her review and recommendations.

2. Geotechnical

- a. The design phase geotechnical engineer should be involved during construction. (Depending on the size of the project, this involvement could range from

telephone consultation to on-site inspections. However, Geotechnical expertise should be available during construction).

- b. A qualified testing laboratory shall be engaged.
- c. The Geotechnical report prepared during the design phase should be provided to the inspector and developer's superintendent prior to construction. Both the inspector's office and field personnel should be familiar with all aspects of the report, including, but not necessarily limited to the following:
 - Existing conditions.
 - Feasibility of using materials from trench for backfill.
 - Appropriate compaction methods for excavated materials.
 - Procedures for selecting and approving borrow sites.
 - Appropriate compaction methods for borrow materials.
 - Recommendations for when select materials should be used.
 - Appropriate methods for compaction of select materials.
 - Appropriate methods for monitoring compaction, including sampling, laboratory testing and field-testing.

The inspection personnel and the developer's superintendent must have a sound working understanding of the geotechnical report in order to effectively implement its recommendations. Therefore, this responsibility should be clearly defined in the scope of services for inspection.

- d. In consultation with the design phase geotechnical engineer, the resident inspector and the developer's superintendent should develop a written plan for implementation of the recommendations of the geotechnical report. This plan should include the following:
 - 1) Identification of the person responsible for insuring adherence to geotechnical report recommendations in the field. Because immediate field decisions are usually required at some time during construction, this person should be well grounded in the subject of backfill materials, methods and compaction, and at least knowledgeable enough to recognize field conditions that do not conform with the geotechnical report and to seek necessary assistance.
 - 2) Establishment of general criteria for use by the field representative in meeting the requirements of the geotechnical report:
 - Frequency of standard Proctor determinations.
 - Frequency of soil density determinations
 - Criteria for using visual characteristics and soil consistency for spot

- determinations of backfill material suitability without consulting geotechnical experts.
 - Criteria for using visual characteristics and soil consistency for spot determinations of compaction suitability without soil density determinations.
- 3) Establishment of procedures for detailed record keeping using a daily inspection report form. This form would require that each of the following be addressed:
- Conditions encountered.
 - Help sought from supervisors, geotechnical engineer, etc.
 - Location of field-tests.
 - Weather conditions.
 - Notations on visual and manual observations
 - Exceptions to geotechnical report recommendations (field decisions).

E. Shop Drawings

Contractor's shop drawings, product data and samples, etc., will be submitted as agreed to in the pre-construction meeting and as provided for in the design professional's contract with the County. Standard Reference Drawing G-5 in the Appendix contains an acceptable shop drawing stamp format. Failure of the design professional to identify deficiencies in submittal for proposed materials does not relieve the contractor of its responsibility to provide materials meeting the requirements of the contract documents.

F. Material Tests

Material tests may be conducted by the County or its authorized agent. Where results of material tests are borderline or questionable, the County will submit test results to the design professional for his/her recommendations.

G. Certification of the Design Intent

The responsible design professional is required to submit to Anne Arundel County Department of Public Works in writing at the time of "Conditional Acceptance" of its capital project, or public portion of a development project, a Certification of Project Completion in accordance with the design intent. The Certification of Project Completion in accordance with the contract documents will be submitted in writing by the agency and/or professional who has direct and continuous responsibility for construction administration and quality assurance monitoring during the entire duration of project construction. Certification(s) will be signed and sealed. The responsible design professional and/or construction monitoring professional signatory to the Certification(s) will be registered professionals in the required technical discipline(s) in

the State of Maryland and duly authorized representative(s) of the responsible agency(s) and/or firm(s).

H. Record Drawings

1. General

Throughout the life of the construction contract, the contractor and the County's inspector, acting together, will maintain a set of "as-built" or redlined contract drawings. It shall be the responsibility of the design professional to complete any modifications of the record drawings required as a result of information provided during construction.

The original construction drawings are to be revised to "as-built" in red waterproof ink and signed by a design professional. Incorrect information shall be x'd out in red ink, with the correct information placed nearby, also in red ink. None of the original design information shall be erased. Each drawing in the set shall bear the words "RECORD DRAWING" in bold letters above the title block, except the first sheet in the set which shall bear the Record Drawing Statement as shown on Standard Reference Drawing G-6 in Appendix B of this Chapter. All record information lettering for the project shall be of the same style and quality as the original contract drawing.

2. Electronic Files

For projects which utilize CAD drawings, the hard copies on mylar will be revised in red ink as described above and will contain the signature and seal of the design professional of record. The electronic file shall show record information as described above except that no provision for plotting record information in red ink is required.

Electronic CAD files, by their nature, can not be signed or sealed by the design professional. They can also be subjected to degradation through improper storage and handling. Therefore, the design professional is protected by an electronic file agreement, as shown in Appendix C of this Chapter, after all electronic files are submitted to the County.

V. APPENDIX

A. Check List - All Contract Drawings

B. Standard General Design Drawings

- G-1 Standard Symbols
- G-2 Drafting Standards
- G-3 Standard Drawing Sizes
- G-4 Standard Title Block

- G-5 Shop Drawing Stamp
 - G-6 Record Drawing Statement
 - G-7 Standard Title Sheet
 - G-8 Normal Utility Locations - Curbed Streets
 - G-9 Normal Utility Locations - Non-Curbed Streets
-
- C. Electronic Files Agreement
 - D. Minimum Required Motor Efficiencies
 - E. Development Project Processing Flow Chart
 - F. Capital Project Processing Flow Chart

APPENDIX A
CHECK LIST
ALL CONTRACT DRAWINGS

LOCATION _____

DATE _____

CHECKED BY _____

For particular items of work, see check list in each Chapter of this Design Manual.

1. Property - All lines and dimensions shown with proper symbols for 100' beyond project limits.
2. Property - Subdivision name, section, block number.
3. Property - Recorded subdivision plat book and page reference.
4. Property - Owners name, lot number and title reference for all lots bordering project.
5. Property - All public R.O.W. and all construction, both temporary and permanent, and other easements shown.
6. Property - Bearings, distances, property corners found, and possession lines should be included for project and 100 ft. beyond project limits.
7. Roads and Streets - All pavement edges and curbs shown with proper symbols and names.
8. Roads and Streets - Alignment, right-of-way and pavement widths shown.
9. Roads and Streets - Pavement type labels
10. Roads and Streets - State Roads labels as such.
11. Roads and Streets - Highway construction file.
12. Topography - Field run checked for roads, poles, fences, buildings, driveways, hydrants, shrubs, trees, paved walks, etc.
13. Topography - Extends 100' beyond project limits.
14. Topography - Checked with record drawings.
15. Utilities - All existing utilities facilities checked and contract numbers under which they were constructed shown.

16. Utilities - All County-owned facilities checked
17. Utilities - Telephone lines and conduit checked.
18. Utilities - Gas mains checked
19. Utilities - Electric lines and conduit checked.
20. General - All existing features shown in ink.
21. General - Vicinity map, 1" = 2000' shows two well-known streets.
22. General - Appropriate scale used and clearly shown
23. General - North arrow correctly oriented to Anne Arundel County grid north (Maryland State Plane Coordinates NAD 83 or NAD 83/91 or NAD 27 FOR ONGOING PROJECTS, only). List controlling stations.
24. General - Three coordinate ticks shown.
25. General - Title of plan.
26. General - Engineer's seal and signature.
27. General - Limits of work clearly shown.
28. General - Title block - Tracers, Designers and Checkers initials, drawing and sheet numbers shown, and revision block information completed when necessary.
29. General - General Notes adequate.
30. General - Bench mark references and description.
31. General - Baseline of survey, coordinates and reference diagrams for baseline survey points shown.

APPENDIX B

**STANDARD GENERAL DESIGN
DRAWINGS**

NATURAL FEATURES

WOODS, UNDERGROWTH AND BRUSH	
MARSH	
TREES	
DECIDUOUS	
EVERGREEN	
STREAMS (NOTE DIRECTION OF FLOW)	
DITCHES (NOTE DIRECTION OF FLOW)	
GULLEYS AND WET WEATHER WATER COURSES	
ROCK (DESCRIBE BY NOTE AND STATE WHETHER OUTCROP OR LOOSE ROCK)	

ROADS AND STREETS

PLAN:

EXISTING CURB	
PROPOSED CURB	
WALKS (NOTE WIDTH AND TYPE)	
CONCRETE VALLEY GUTTER	
EDGE MACADAM OR CONCRETE ROAD	
EDGE DIRT OR GRAVEL ROAD	
EXISTING RIGHT-OF-WAY LINE	
EXISTING PROPERTY LINE	
CENTERLINE OF EXISTING R/W OR ROAD	
CENTERLINE OF PROPOSED R/W OR ROAD	
TRANSIT LINE (SHOW IN RED)	
(SHADE IN FOR HUB OR NAIL AND CAP)	
P. I. TRANSIT LINE OR C/L	
P. I. FACE CURB LINE (NOTE CORNER)	
HORIZONTAL CURVES:	
POINT OF CURVATURE	P.C.
POINT OF TANGENT	P.T.
POINT OF INTERSECTION	P.I.
POINT OF REVERSE CURVATURE	P.R.C.
POINT OF COMPOUND CURVATURE	P.C.C.

ARCHITECTURAL & STRUCTURAL SYMBOLS

CONCRETE	
METAL	
WOOD	
GRAVEL	
SAND	
RIPRAP	
EARTH	

ROADS AND STREETS

PROFILE:

ESTABLISHED TOP CURB GRADE	
(CIRCLES DESIGNATE VERTICAL CURVE POINTS, P. I.'S OF CURB LINES AND P. I.'S OF INTERSECTING STREETS AND ALLEYS)	
CENTERLINE OF EXISTING ROAD	
PROPERTY LINES (LABEL EACH SIDE)	
VERTICAL CURVES:	
POINT OF VERTICAL CURVE	P.V.C.
POINT OF VERTICAL TANGENT	P.V.T.
POINT OF VERTICAL INTERSECTION	P.V.I.
POINT ON CURVE	P.O.C.
POINT OF VERTICAL REVERSE CURVE	P.V.R.C.
POINT OF VERTICAL COMPOUND CURVE	P.V.C.C.

SURVEYORS SYMBOLS

BENCH MARK		B.M. NO.
TRAVERSE HUB		
STAKE WITH TACK CENTER		
STAKE WITHOUT TACK		
IRON PROPERTY PIPE		
NAIL OR SPIKE		
PROPERTY & BOUNDARY STONES		
CITY BOUNDARY		
DISTRICT BOUNDARY		
AREA BOUNDARY		

LAND ACQUISITION

TEMPORARY CONSTRUCTION AREA	
SLOPE EASEMENT	
AREA TO BE RELEASED	
EXISTING UTILITY R/W	
PROPOSED DRAINAGE & UTILITY R/W (COLOR GREEN)	
STREAM RELOCATION AND BRIDGE EASEMENT (COLOR BLUE)	
EXISTING ROADS & STREETS R/W	
PROPOSED ROADS & STREETS R/W (COLOR GREEN)	
EXIST. R/W'S (AGENCIES OTHER THAN BALTO. CO.)	

ANNE ARUNDEL COUNTY DEPARTMENT OF PUBLIC WORKS	APPROVED	STANDARD GENERAL DESIGN DRAWING	G - 1.1
	DATE:		

UTILITIES

UTILITIES

EXISTING WORK: (SHOW IN INK)

REFERENCE SHEET TO SHEET:

SANITARY SEWER	---
SANITARY SEWER MANHOLE	⊙
SANITARY SEWER TERMINAL MANHOLE	⊙
STORM DRAINS, MISC. CULVERTS	---
STORM DRAIN MANHOLE	⊙
STORM DRAIN JUNCTION CHAMBER	⊕
INLET, CURB TYPE	▭
INLET GRATING TYPE	▭
INLET, CURB AND GRATING TYPE	▭
WATER MAINS	---
WATER MAIN VALVE VAULT	⊙
WATER METER BOX	⊙
WATER VALVE, TEE, AND CROSS	⊕
WATER REDUCER, Y BRANCH AND BEND	⊕
WATER BLOW-OFF AND AIR RELEASE	⊕
WATER FIRE HYDRANT	⊕
WATER STAND PIPE	⊙
ELEVATED WATER TANK	⊙
FIRE CISTERN	⊕
CONDUITS (ELECTRIC AND TELEPHONE)	---c---
GAS MAINS	---
GAS METERS	⊙
GAS DRIP, STOP OR PLUG	■

SANITARY SEWER	
STORM DRAIN	
WATER	
OTHER PROPOSED UTILITIES (SHOW IN PENCIL)	
SANITARY SEWER	
STORM DRAIN	
WATER	

MISCELLANEOUS

FENCES, WOOD	--//--//--
FENCES, IRON	--x--x--
FENCES, WIRE, BARB & SMOOTH	--x--x--
FENCES, HEDGE (SHOW IN GREEN)	~~~~~
FENCES, STONE, BRICK, CONCRETE; WALLS	///////
POLES: G AND E NO. 1000	T T T T
OR C AND P NO. 1000	
OR STREET LIGHT	
RAILROAD AND STREETCAR TRACKS	
EXCAVATION OR CUT	
EMBANKMENT OR FILL	
SINK HOLES, POT HOLES, ETC.	
CELLAR ELEVATION	C.E. 178.45
CONTOUR LINES (NUMBERED LINES HEAVY)	400
UNGLAZED CLAY PIPE EXTRA STRENGTH	V.C.P.X.
VITRIFIED CLAY PIPE	V.C.P.
EXTRA STRENGTH	V.C.P.X.
REINFORCED CONCRETE SEWER PIPE	R.C.S.P.
GALVANIZED CORRUGATED METAL PIPE	C.M.P.
REINFORCED CONCRETE CULVERT PIPE	R.C.C.P.
BITUMINOUS COATED CORRUGATED METAL PIPE	B.C.C.M.P.
FULLY PAVED INVERT	B.C.C.M.P.
GALVANIZED IRON	G.I.
WROUGHT IRON	W.I.
PRESTRESSED CONCRETE CYLINDER PIPE	P.C.C.P.
CAST IRON PIPE	C.I.P.
ASBESTOS CEMENT PIPE	A.C.P.
CAST IRON SOIL PIPE (EXTRA STRENGTH)	C.I.S.P.X.
BIT. COATED CORRUGATED METAL PIPE ARCH	B.C.C.M.P.A.
FULLY PAVED INVERT	B.C.C.M.P.A.
POLYVINYL CHLORIDE	PVC
DUCTILE IRON PIPE	D.I.P.
HIGH DENSITY POLYETHYLENE	H.D.P.E.

PROPOSED WORK: (SHOW IN PENCIL)

PIPE LINES	---
SANITARY SEWER AND STORM DRAIN MH	
SANITARY SEWER TERMINAL MANHOLE	
SANITARY SEWER HOUSE CONNECTION	
STORM DRAIN JUNCTION CHAMBER	
STORM DRAIN INLET AND CATCH BASINS	
WATER HOUSE SERVICE AND METER BOX	
WATER VALVE, TEE AND CROSS	
WATER REDUCER, Y BRANCH AND BEND	
WATER BLOW-OFF, AND AIR RELEASE, AND FIRE HYDRANT	

ANNE ARUNDEL
COUNTY
DEPARTMENT OF
PUBLIC WORKS

APPROVED

DATE:

STANDARD GENERAL DESIGN DRAWING

















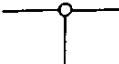











STANDARD SYMBOLS

G - 1.2

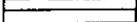
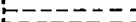
TRAFFIC SIGNAL SYMBOLS

PROPOSED

EXISTING













	METAL POLE	
	SINGLE MAST ARM AND POLE	
	TWIN MAST ARM AND POLE	
	TRIPLE MAST ARM AND POLE	
	WOOD POLE	
	LIGHTING ARM AND LUMINAIRE ON METAL POLE	
	LIGHTING ARM AND LUMINAIRE ON WOOD POLE	
	PEDESTRIAN PUSH BUTTON AND SIGN ON METAL POLE	
	POLE MOUNTED CABINET	
	BASE MOUNTED NEMA SIZE "5" CABINET AND CONCRETE PAD	
	BASE MOUNTED NEMA SIZE "6" CABINET AND CONCRETE PAD	
	HANDHOLE	
	LOOP DETECTOR (6X30)	
	LOOP DETECTOR (6X6)	
	MICRO LOOP PROBE SET	
	CONDUIT	

ANNE ARUNDEL COUNTY DEPARTMENT OF PUBLIC WORKS	APPROVED	STANDARD GENERAL DESIGN DRAWING TRAFFIC SIGNAL SYMBOLS	G - 1.3
	_____ _____ DATE: _____		









TRAFFIC SIGNAL SYMBOLS

PROPOSED

EXISTING

	SINGLE POST GROUND MOUNTED SIGN	
	DOUBLE POST GROUND MOUNTED SIGN	
	SPAN WIRE AND MAST ARM MOUNTED SIGN	
	VEHICLE SIGNAL HEAD	
	PEDESTRIAN SIGNAL HEAD	
	OPTICAL PRE-EMPTION DETECTOR EYE	

DESIGN STANDARD SYMBOLS

	VEHICLE SIGNAL HEAD
	VEHICLE SIGNAL HEAD WITH BACKPLATE
	PEDESTRIAN SIGNAL HEAD
	OPTICALLY PROGRAMMED VEHICLE SIGNAL HEAD
	LOUVERS ON SIGNAL FACE
	WOOD POLE WITH TRANSFORMER
	PAD MOUNTED TRANSFORMER
	BACK GUY

ANNE ARUNDEL COUNTY DEPARTMENT OF PUBLIC WORKS	APPROVED _____ _____ DATE: _____	STANDARD GENERAL DESIGN DRAWING TRAFFIC SIGNAL SYMBOLS	G - 1.4
---	---	---	---------

GENERAL DRAFTING STANDARDS

LETTERING

(A) LETTERING IN GENERAL SHOULD BE VERTICAL USING EITHER 5/32", 0 SIZE, LEROY OR COMPARABLE TYPEWRITER SIZE. ALL LETTERING SHALL BE IDENTICAL.

ABCDEFGHIJKLMNOPQRSTUVWXYZ

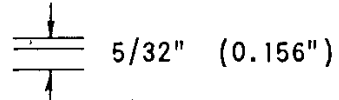

abcdefghijklmnopqrstuvwxyz

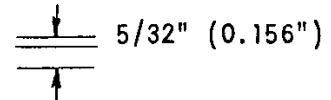

(B) ALL NOTES, DESCRIPTIONS, ETC. SHALL BE EITHER 3/32", 000 SIZE LEROY, OR A COMPARABLE TYPEWRITER SIZE. CROWDING OF NOTES INTO A SMALL SPACE SHALL BE AVOIDED.

All courses and distances shown.

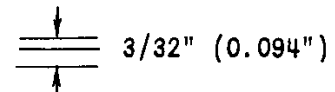

(C) STREET NAMES (CAPITALIZED) SHALL BE EITHER 7/32", NO.3 SIZE LEROY OR COMPARABLE TYPEWRITER SIZE.

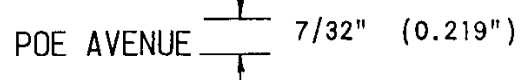

(D) ALL TITLES SHALL BE 6/32" IN SIZE UNLESS TITLE IS TOO LONG FOR SPACE ALLOTTED. THEN A 5/32" SIZE WILL BE USED. USE OF EQUIVALENT SIZE LEROY OR TYPEWRITER SIZE IS PERMISSIBLE.

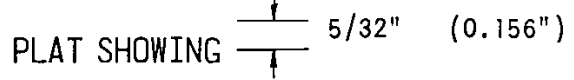
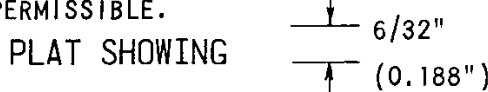

(E) UTILITIES, HOUSE NUMBERS, ETC. SHALL BE EITHER 1/8" SIZE OR TYPEWRITER SIZE.

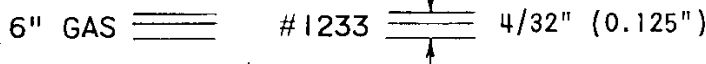

(F) CADD LETTERING SHALL MEET THE ABOVE SPECIFICATIONS

LINE WORK

- (A) ALL LINES SHOULD HAVE THE SAME DENSITY. THE DIFFERENCE BETWEEN THE VARIOUS WEIGHTS SHOULD BE IN THE WIDTH OF THE LINES.
- (B) THE SELECTION OF LINES IN PREPARING A DRAWING WILL ALWAYS SHOW THE IMPORTANT FEATURES MORE PROMINENTLY THAN THE SECONDARY FEATURES.
- (C) DIMENSION LINES, CENTER LINES, BASE LINES, ETC. SHOULD BE SHOWN WITH THE SAME DENSITY AS OTHER LINES BUT THIN IN WIDTH.
- (D) LEADERS SHALL BE MADE AS SHORT AS POSSIBLE
- (E) LEADERS SHALL BE INDICATED

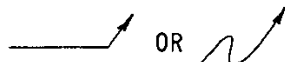

(F) A DIFFERENT GRADE SHALL BE USED FOR LINES OF DIFFERENT WEIGHT.

ANNE ARUNDEL COUNTY DEPARTMENT OF PUBLIC WORKS	APPROVED _____ _____ DATE: _____	STANDARD GENERAL DESIGN DRAWING DRAFTING STANDARDS	G - 2
---	---	---	-------

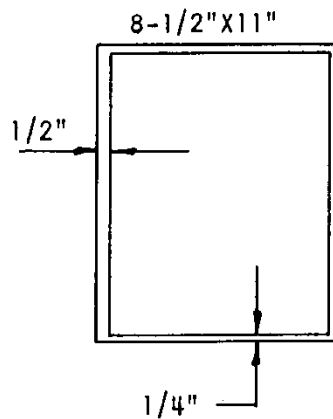

FOR RIGHT-OF-WAY
EASEMENT PLATS, ONLY.

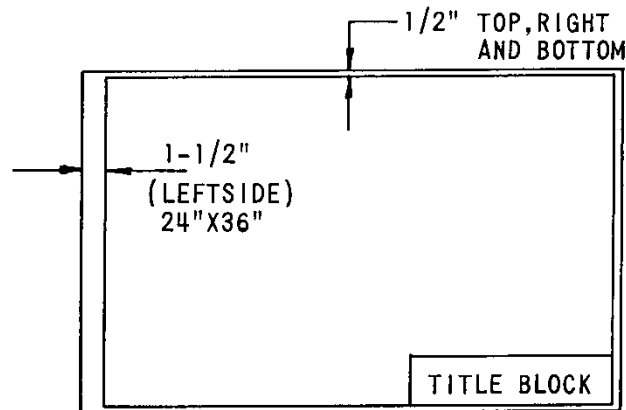

STANDARD SHEET SIZE FOR ALL DRAWINGS.

NOTE: EXCEPTION CAN BE MADE ON ARCHITECTURAL DRAWINGS WHERE SHEET SIZE WOULD NECESSITATE A MATCH LINE. HOWEVER, THE STANDARD SHEET SIZE SHALL NOT EXCEED 30"X40".

ALL DESIGN DRAWINGS FOR UTILITIES, ROADS AND BRIDGES COVERED IN THESE STANDARDS SHALL BE ORIGINAL DRAWINGS SUBMITTED ON POLYESTER DRAFTING FILM (MINIMUM THICKNESS 0.004 INCHES) OF THE SIZES INDICATED ABOVE. THE DIMENSIONS SHOWN ARE THE OVERALL DIMENSIONS OF THE DRAWINGS. MATERIAL NOT FURNISHED BY DEPARTMENT OF PUBLIC WORKS. TITLE BLOCK SHALL BE SHOWN IN AREA AS OUTLINED ABOVE.

ANNE ARUNDEL COUNTY DEPARTMENT OF PUBLIC WORKS	APPROVED _____ _____ DATE: _____	STANDARD GENERAL DESIGN DRAWING STANDARD DRAWING SIZE	G - 3
---	---	--	-------

MATCH LINE

DESIGN PROFESSIONAL'S TITLE NAME AND ADDRESS ①	REVISIONS	
	NO.	DESCRIPTION
	BY	DATE

ANNE ARUNDEL COUNTY
DEPARTMENT OF PUBLIC WORKS

APPROVED	DATE	APPROVED	DATE
CHIEF BUREAU OF HIGHWAYS & PARKS		PROJECT ENGINEER	
APPROVED	DATE	APPROVED	DATE
CHIEF, TRAFFIC ENGINEERING DIVISION		CHIEF, RIGHT OF WAY SERVICES	

SCALE 1/2" = 1"

LOWER RIGHT HAND
CORNER OF BORDER

BUREAU OF HIGHWAYS AND PARKS, TRAFFIC ENGINEERING DIVISION

SCALE 1/2" = 1"

MATCH LINE

DESIGN PROFESSIONAL'S TITLE NAME AND ADDRESS ①	REVISIONS	
	NO.	DESCRIPTION
	BY	DATE

LOWER RIGHT HAND
CORNER OF BORDER

ANNE ARUNDEL COUNTY
DEPARTMENT OF PUBLIC WORKS

APPROVED	DATE	APPROVED	DATE
CHIEF ENGINEER		PROJECT MANAGER	
APPROVED	DATE	APPROVED	DATE
ASSISTANT CHIEF ENGINEER		CHIEF, RIGHT OF WAY SERVICES	

SCALE 1/2" = 1"

LEGEND

- ① PROFESSIONAL SEAL AND SIGNATURE
- ② TYPE OF PROJECT: ROADS, TRAFFIC, STORM DRAINS, SANITARY SEWER, ETC.
- ③ PROJECT NAME

REVISIONS

ANNE ARUNDEL COUNTY DEPARTMENT OF PUBLIC WORKS	STANDARD GENERAL DESIGN STANDARD TITLE BLOCKS FOR PUBLIC WORKS PROJECTS
APPROVED _____ CHIEF ENGINEER	_____ DESIGN ENGINEER
_____ DATE:	_____ DATE:

G4.1

DESIGN PROFESSIONAL'S TITLE NAME AND ADDRESS ①	REVISIONS <table border="1" style="width: 100%; border-collapse: collapse;"> <thead> <tr> <th style="width: 10%;">NO.</th> <th style="width: 70%;">DESCRIPTION</th> <th style="width: 10%;">BY</th> <th style="width: 10%;">DATE</th> </tr> </thead> <tbody> <tr><td> </td><td> </td><td> </td><td> </td></tr> <tr><td> </td><td> </td><td> </td><td> </td></tr> <tr><td> </td><td> </td><td> </td><td> </td></tr> <tr><td> </td><td> </td><td> </td><td> </td></tr> <tr><td> </td><td> </td><td> </td><td> </td></tr> <tr><td> </td><td> </td><td> </td><td> </td></tr> <tr><td> </td><td> </td><td> </td><td> </td></tr> <tr><td> </td><td> </td><td> </td><td> </td></tr> <tr><td> </td><td> </td><td> </td><td> </td></tr> <tr><td> </td><td> </td><td> </td><td> </td></tr> </tbody> </table>	NO.	DESCRIPTION	BY	DATE																																								
NO.	DESCRIPTION	BY	DATE																																										

MATCH LINE

ANNE ARUNDEL COUNTY DEPARTMENT OF PLANNING AND CODE ENFORCEMENT	
APPROVED _____ DATE _____	SCALE _____ DRAWN BY _____ CHECKED BY _____ SHEET NO. _____ OF _____ PROJECT NO. _____ PROPOSAL NO. _____
CHIEF ENGINEER _____ PROJECT MANAGER _____	② ③

MATCH LINE

LOWER RIGHT HAND
CORNER OF BORDER

DEVELOPMENT PROJECTS

SCALE 1/2" = 1"

- ① PROFESSIONAL SEAL AND SIGNATURE
- ② TYPE OF PROJECT: ROADS, STORM DRAINS, SANITARY SEWER, ETC.
- ③ PROJECT NAME

ANNE ARUNDEL COUNTY DEPARTMENT OF PUBLIC WORKS	APPROVED _____ CHIEF ENGINEER _____ _____ DESIGN ENGINEER _____ DATE: _____	REVISIONS <table border="1" style="width: 100%; border-collapse: collapse;"> <tr><td> </td></tr> <tr><td> </td></tr> <tr><td> </td></tr> <tr><td> </td></tr> <tr><td> </td></tr> </table>					
STANDARD GENERAL DESIGN STANDARD TITLE BLOCKS FOR P.A.C.E. DEVELOPMENT PROJECTS		G4.2					

DRAWN BY _____ TRACED BY _____ CHECKED BY _____ DRAWING NO. _____	ANNE ARUNDEL COUNTY PLANNING & CODE ENFORCEMENT	SCALE _____		REVISIONS	
		DATE _____		DATE	BY
		PROJECT NO. _____			
		APPROVED _____		* TITLE _____	

* CHIEF ENGINEER - SUBDIVISION PROJECTS OR
CHIEF TECHNICAL SERVICES - COMMERCIAL AND RESIDENTIAL BUILDING PERMIT PROJECTS

P.A.C.E. PROJECTS

LOWER RIGHT HAND CORNER
OF BORDER

DRAWN BY _____ TRACED BY _____ CHECKED BY _____ DRAWING NO. _____	ANNE ARUNDEL COUNTY DEPARTMENT OF PUBLIC WORKS	SCALE _____		REVISIONS	
		DATE _____		DATE	BY
		PROJECT NO. _____			
		APPROVED _____		CHIEF RIGHT OF WAY SERVICES _____	

PUBLIC WORKS PROJECTS

LOWER RIGHT HAND CORNER
OF BORDER

SCALE 1" = 1"

ANNE ARUNDEL COUNTY DEPARTMENT OF PUBLIC WORKS	APPROVED _____	<p>STANDARD GENERAL DESIGN STANDARD TITLE BLOCKS FOR RIGHT - OF - WAY PLATS</p>	REVISIONS
	CHIEF ENGINEER _____		
	DESIGN ENGINEER _____		
	DATE: _____		
			G4.3

COMPANY NAME	ACTION
ADDRESS	<input type="checkbox"/> ACCEPTED AS SPECIFIED <input type="checkbox"/> ACCEPTED AS EQUAL TO SPECIFIED <input type="checkbox"/> ACCEPTED AS NOTED <input type="checkbox"/> REVISE AND RESUBMIT <input type="checkbox"/> REJECTED <input type="checkbox"/> INFORMATIONAL PURPOSE ONLY
COMMENTS:	
DATE _____ BY _____	
ACCEPTANCE DOES NOT RELIEVE CONTRACTOR FROM RESPONSIBILITY OF COMPLIANCE WITH THE CONTRACT DOCUMENTS.	

ACTUAL SIZE

ANNE ARUNDEL COUNTY DEPARTMENT OF PUBLIC WORKS	APPROVED _____ _____ DATE: _____	STANDARD GENERAL DESIGN DRAWING SHOP DRAWING STAMP	G - 5
---	---	---	-------

RECORD CERTIFICATION

I HEREBY CERTIFY TO THE BEST OF MY KNOWLEDGE AND PERSONAL BELIEF, THAT THE DEVIATING SURVEYABLE FEATURES OF THE COMPLETED WORK SHOWN ON THESE PLANS WAS CONSTRUCTED TO THE LINES AND GRADES SHOWN.

DESIGN PROFESSIONAL

()

(DATE) P.E. NO.

ANNE ARUNDEL COUNTY DEPARTMENT OF PUBLIC WORKS	APPROVED _____ _____ DATE: _____	STANDARD GENERAL DESIGN DRAWING RECORD DRAWING STATEMENT	G - 6
---	---	---	-------

<p>INDEX OF DRAWINGS</p>	<p>ANNE ARUNDEL COUNTY MARYLAND DEPARTMENT OF PUBLIC WORKS</p> <p>PROJECT NAME PROJECT NUMBER</p>	<p>VICINITY MAP (1" = 2000')</p>
<p>NON-STANDARD SYMBOL LEGEND</p>	<p>LOCATION MAP (1" = 200')</p> <p>NOTE: LOCATION MAP SCALE FOR HIGHWAY PROJECTS MAY BE SMALLER TO ACCOMMODATE SIZE OF PROJECT.</p>	<p>GENERAL NOTES</p>
		<p>TITLE BLOCK</p>
<p>ANNE ARUNDEL COUNTY DEPARTMENT OF PUBLIC WORKS</p>	<p>APPROVED</p> <p>_____ CHIEF ENGINEER</p> <p>_____ DESIGN ENGINEER</p>	<p>STANDARD GENERAL DESIGN DRAWING STANDARD TITLE SHEET</p>
		<p>G-7</p>

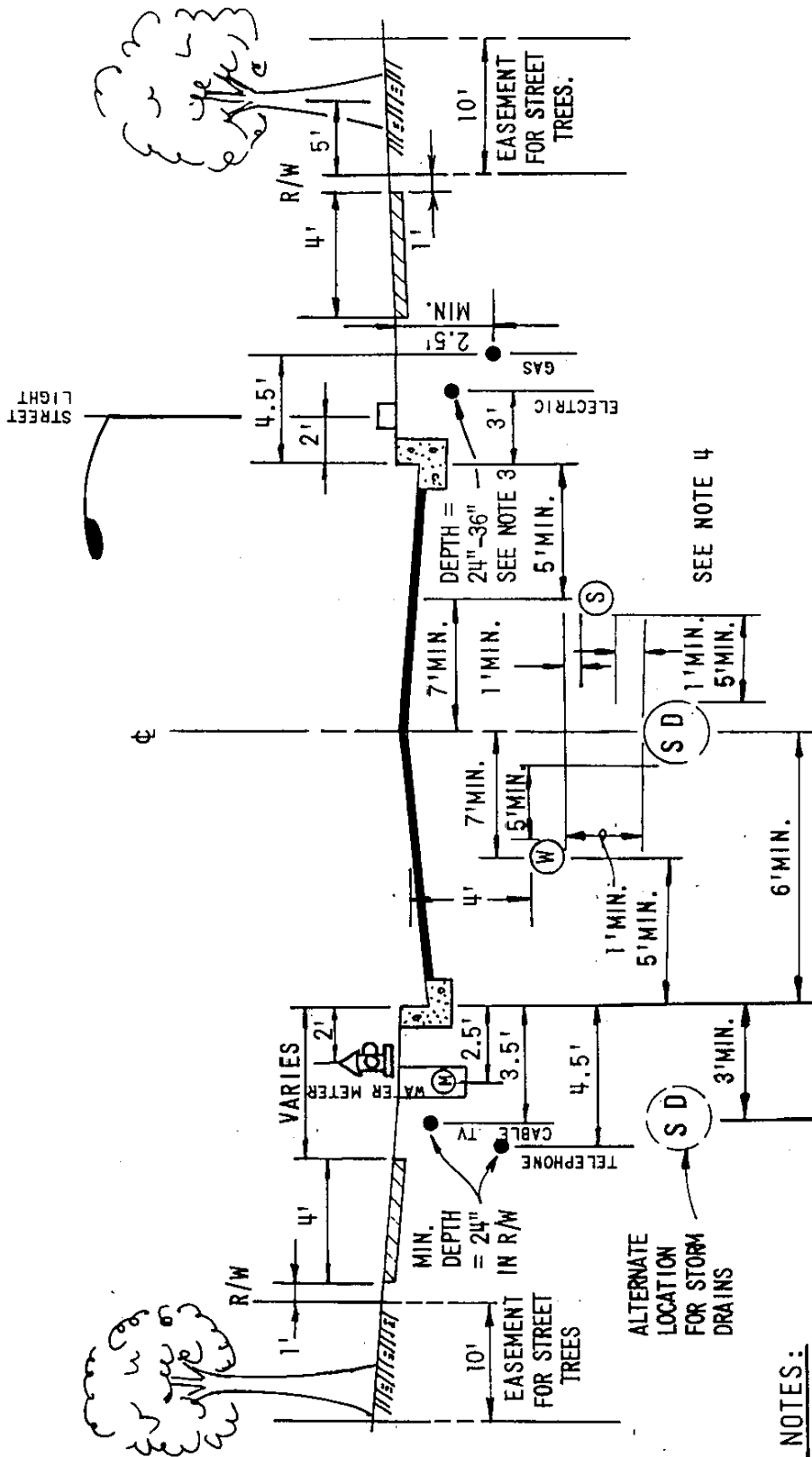

NOTES:

1. THE DEPARTMENT OF PUBLIC WORKS SHALL APPROVE THE UTILITY LOCATION ARRANGEMENT FOR GIVEN STREET PROJECT.
2. GAS, ELECTRIC AND TELEPHONE LINES MAY BE PLACED IN SAME TRENCH AT THE OPTION OF THE BALTIMORE GAS AND ELECTRIC COMPANY AND BELL ATLANTIC TELEPHONE COMPANY.
3. ELECTRIC: 0-600V 24" COVER, OVER 600V 36" COVER
 TELEPHONE: MAIN SERVICE 24" COVER, RESIDENTIAL CONNECTION 24" COVER IN STREET R/W
 CABLE TV: 24" COVER IN STREET R/W.
4. IF SEPARATION MUST BE LESS THAN 10' HORIZONTALLY, VERTICAL SEPARATION SHALL BE 6'.

SEE NOTE 4

<p>ANNE ARUNDEL COUNTY DEPARTMENT OF PUBLIC WORKS</p>	<p>APPROVED</p>	<p>G - 8</p>
<p>STANDARD GENERAL DESIGN DRAWING NORMAL UTILITY LOCATIONS - CURBED STREETS</p>		

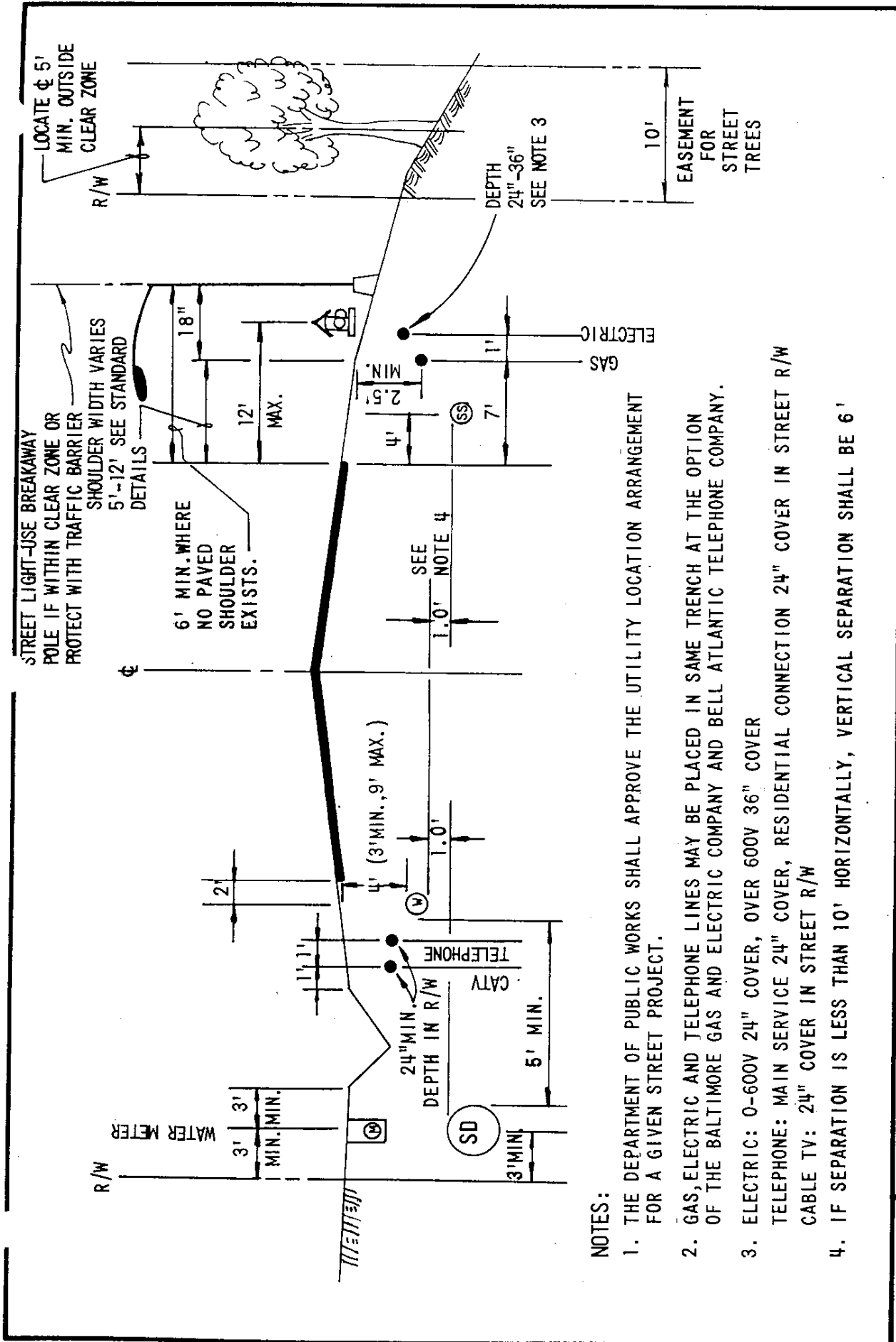

NOTES:

1. THE DEPARTMENT OF PUBLIC WORKS SHALL APPROVE THE UTILITY LOCATION ARRANGEMENT FOR A GIVEN STREET PROJECT.
2. GAS, ELECTRIC AND TELEPHONE LINES MAY BE PLACED IN SAME TRENCH AT THE OPTION OF THE BALTIMORE GAS AND ELECTRIC COMPANY AND BELL ATLANTIC TELEPHONE COMPANY.
3. ELECTRIC: 0-600V 24" COVER, OVER 600V 36" COVER
TELEPHONE: MAIN SERVICE 24" COVER, RESIDENTIAL CONNECTION 24" COVER IN STREET R/W
CABLE TV: 24" COVER IN STREET R/W
4. IF SEPARATION IS LESS THAN 10' HORIZONTALLY, VERTICAL SEPARATION SHALL BE 6'

<p>ANNE ARUNDEL COUNTY DEPARTMENT OF PUBLIC WORKS</p>	<p>APPROVED</p>	<p>STANDARD GENERAL DESIGN DRAWING NORMAL UTILITY LOCATIONS - NON-CURBED STREETS</p>	<p>G - 9</p>
---	-----------------	--	--------------

APPENDIX C

Electronic Files Agreement

_____ Agrees to transfer the following electronic files associated with
the (Design Professional)

(Project Name and Identification)

All files on computer disks will be submitted for a 30-day acceptance period. During the acceptance period, the County shall verify the integrity of all electronic files. Files found to be defective will be replaced by the Design Professional. Due to potential deterioration of data stored on computer disks or any other form of electronic media, changes in technology associated with electronic media, or potential for modification without the Design Professional's knowledge, the County will not hold the Design Professional liable for the completeness, correctness or readability of the electronic media after the 30 day acceptance period. A printed record set of the data on the electronic file will be provided by the Design Professional for permanent storage by the County.

The Design Professional will not be responsible for the accuracy of the data within the electronic files resulting from County manipulations, deletions, and/or design modifications made after the transfer of the electronic files.

The Design Professional will not be liable for the electronic files after transfer, including, but not limited to, any computer viruses that may be contracted by the Contractor's system as a result of the transfer.

APPENDIX D
MINIMUM REQUIRED
MOTOR EFFICIENCIES

<u>MOTOR SIZE (HORSEPOWER)</u>	<u>MINIMUM REQUIRED EFFICIENCY *</u>
1	82.5
1.5	84.0
2	84.0
3	87.5
5	87.5
7.5	89.5
10	89.5
15	91.0
20	91.0
25	92.4
30	92.4
40	93.0
50	93.0
60	93.6
75	94.1
100	94.5
125	94.5
150	95.0
200	95.0
250	95.0

* NAMEPLATE RATING (IEEE TEST PROCEDURE 112, METHOD B)
SOURCE: BG&E

DEVELOPMENT PROJECT
PROCESSING FLOW CHART

DEVELOPMENT PROJECTS

TO **PACE** FOR SUBDIVISION AND / OR
PERMIT REVIEW



REVIEW AND APPROVAL OF PUBLIC SHEETS,
TRAFFIC CONTROL PLAN, COST ESTIMATES
AND UTILITY PLANS BY **PACE**



TO **PACE** FOR AGREEMENT WITH
APPROVED PLANS



UPON EXECUTED UTILITY AGREEMENT / PUBLIC
WORKS AGREEMENT, **PACE** PERMIT
APPROVAL



CONSTRUCTION

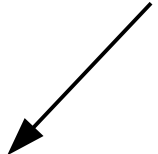

INSPECTION OF UTILITIES
ROADS AND STORM DRAINS
BY **PACE**

INSPECTION OF SEDIMENT
CONTROL, STORMWATER
MANAGEMENT AND BUILDINGS
BY **PACE**

CAPITAL PROJECT
PROCESSING FLOW CHART
CAPITAL PROJECTS

